

# Computer Networks & Data Communication

Dr. Chander Kant, KUK

9416303050

Major Issues Discussed are as Follows..

**Network Characterization:** Goals and Applications; Categorization according to Size, Purpose, Design issues & Transmission Technologies; Network Architecture and Service Models; Design issues for the Layers; OSI and TCP/IP Reference Models; Functions of layers and protocols of TCP/IP; Comparison of OSI & TCP/IP ; Data Transmission using TCP/IP.

**Networking Models & Applications:** Centralized, Decentralized, and Distributed; Client-Server and Peer-to-Peer; File sharing & Web- based; Content Distributed Networks.

**Introduction to Example Networks:** The Internet and its Conceptual View ; Accessing The Internet; Connection-Oriented Networks: X.25, Frame Relay and ATM

**Data Communication Concepts & Components:** Digital and Analog Data and Signals, Asynchronous and Synchronous transmission; bit rate, baud, bandwidth Channel Capacity; Nyquist Bit Rate, Shannon Capacity; Network Performance Parameters; Transmission Impairment.

**Connecting Devices & Transmission Media:** Network Interface Cards, Connectors, Hubs, Transceivers & Media Connectors; Link-Layer Switches, Bridge, Routers, Gateways, Virtual LANs; Guided Transmission Media; Wireless transmission; Satellite communication.

**Data Encoding & Modulation Techniques:** NRZ, NRZ-I, Manchester and Differential Manchester encoding; 4B/5B ; Pulse Code Modulation & Delta Modulation Digital to Analog encoding.

**Switching and Bandwidth Utilization:** Methods of Switching; Virtual Circuit & Datagram Networks; Multiplexing; Spread Spectrum.

**Wired Networks and The Local Loop:** Telephone Networks; Modems and Modulation Techniques; Broadband and ADSL; Internet over Cable; ADSL Versus Cable; Hybrid Fiber-Coaxial Network;Fiber-to-the-Home Broadband.

**Data Link Layer:** Communication at the Data Link Layer; Nodes and Links; Link Layer Addressing; Examples of Data Link layer protocols.

**Design Issues:** Framing techniques: Byte Oriented and Bit Oriented Protocols; Error Control: Error Detection and Correction; Sliding Window Flow Control Protocols.

**Media Access Control:** Aloha, CSMA, CSMA/CD, CSMA/CA; Collision free protocols with Controlled Access; Limited Contention Protocols; Channelization: FDMA, TDMA, CDMA; Wavelength Division Multiple access for Fiber-Optic Data Communication.

**IEEE LAN standards:** Ethernet (Physical specifications, Encoding, Frame Format & MAC protocol); Binary Exponential Backoff algorithm; Token Ring and FDD

**Introduction to Wireless Networks:** IEEE 802.11 Wireless LAN; Wi-Max; Bluetooth and other wireless PAN technologies & their applications; Cellular Network Generations; GSM & CDMA Technologies.

**Transport layer:**Addressing, Services and Protocols; TCP and UDP services & header formats.

**Network Layer:** Services, Routing Algorithms: Shortest path Routing, Flooding, Distance Vector Routing, Link State Routing, Hierarchical Routing, Multi Cast Routing, Routing for Mobile hosts.

**Network layer in TCP/IP:** Basic characteristics of IP protocol; addressing and header format of IPv4 ; IPv6: Major goals& features.

**Congestion Control & Quality of Service:** General Principals; Congestion control in Virtual – Circuit Subnets; Congestion Control in Datagram Subnets: Choke packets, Load Shedding; Random Early Detection, Jitter Control; Over provisioning, Buffering, Traffic Shaping, Leaky bucket, token bucket, Resource Reservation, Admission Control, Packet Scheduling.

# DATA COMMUNICATIONS

Data communications are the exchange of data between two devices via some form of transmission medium such as a wire cable. For data communications to occur, the communicating devices must be part of a communication system made up of a combination of hardware (physical equipment) and software (programs). The effectiveness of a data communications system depends on four fundamental characteristics: delivery, accuracy, timeliness, and jitter.

1. **Delivery.** The system must deliver data to the correct destination. Data must be received by the intended device or user and only by that device or user.
2. **Accuracy.** The system must deliver the data accurately. Data that have been altered in transmission and left uncorrected are unusable.
3. **Timeliness.** The system must deliver data in a timely manner. Data delivered late are useless. In the case of video and audio, timely delivery means delivering data as they are produced, in the same order that they are produced, and without significant delay. This kind of delivery is called *real-time* transmission.
4. **Jitter.** Jitter refers to the variation in the packet arrival time. It is the uneven delay in the delivery of audio or video packets.

## Components:

A data communications system has five components.

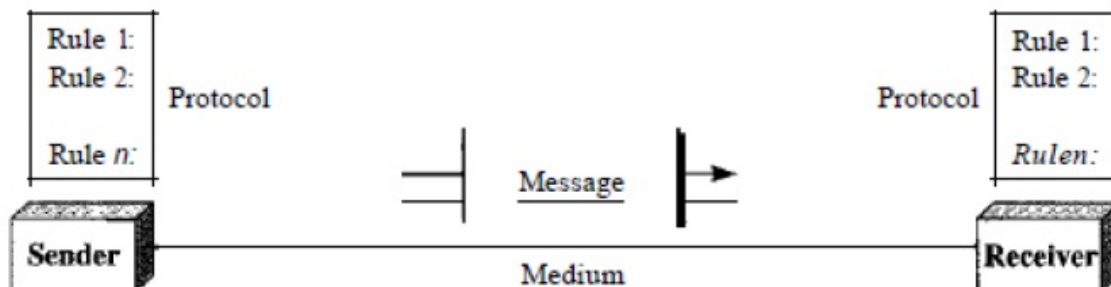

**1. Message.** The message is the information (data) to be communicated. Popular forms of information include text, numbers, pictures, audio, and video.

**2. Sender.** The sender is the device that sends the data message. It can be a computer, workstation, telephone handset, video camera, and so on.

**3. Receiver.** The receiver is the device that receives the message. It can be a computer, workstation, telephone handset, television, and so on.

**4. Transmission medium.** The transmission medium is the physical path by which a message travels from sender to receiver. Some examples of transmission media include twisted-pair wire, coaxial cable, fiber-optic cable, and radio waves

**5. Protocol.** A protocol is a set of rules that govern data communications. It represents an agreement between the communicating devices.

## **DATA TRANSMISSION MODES**

Communication between two devices can be simplex, half-duplex, or full-duplex.

### **Simplex:**

In simplex mode, the communication is unidirectional, as on a one-way street. Only one of the two devices on a link can transmit; the other can only receive. Keyboards and traditional monitors are examples of simplex devices. The keyboard can only introduce input; the monitor can only accept output. The simplex mode can use the entire capacity of the channel to send data in one direction.

### **Half-Duplex:**

In half-duplex mode, each station can both transmit and receive, but not at the same time. When one device is sending, the other can only receive, and vice versa. In a half-duplex transmission, the entire capacity of a channel is taken over by whichever of the two devices is transmitting at the time. Walkie-talkies and CB (citizens band) radios are both half-duplex systems. The half-duplex mode is used in cases where there is no need for communication in both directions at the same time; the entire capacity of the channel can be utilized for each direction.

**Full-Duplex:**

In full-duplex both stations can transmit and receive simultaneously. The full-duplex mode is like a two way street with traffic flowing in both directions at the same time. In full-duplex mode, signals going in one direction share the capacity of the link: with signals going in the other direction. One common example of full-duplex communication is the telephone network. When two people are communicating by a telephone line, both can talk and listen at the same time. The full-duplex mode is used when communication in both directions is required all the time. The capacity of the channel, however, must be divided between the two directions.

---

*Dataflow (simplex, half-duplex, and full-duplex)*

---

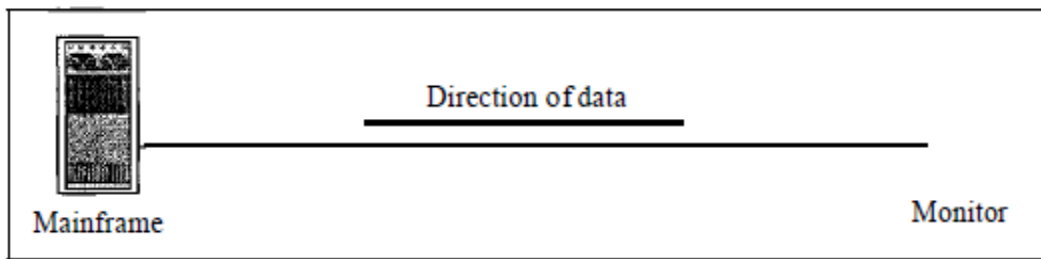

a. Simplex

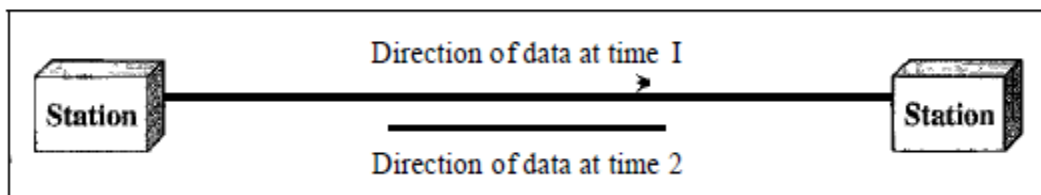

b. Half-duplex

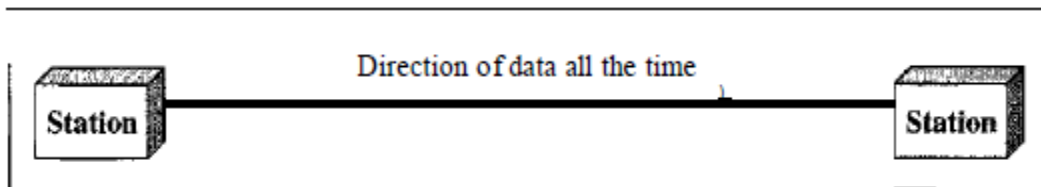

c. Full-duplex

---

# **NETWORKS**

A network is a set of devices (often referred to as *nodes*) connected by communication links. A node can be a computer, printer, or any other device capable of sending and/or receiving data generated by other nodes on the network.

## **Network Criteria**

A network must be able to meet a certain number of criteria. The most important of these are performance, reliability, and security.

### **Performance:**

Performance can be measured in many ways, including transit time and response time. Transit time is the amount of time required for a message to travel from one device to another. Response time is the elapsed time between an inquiry and a response. The performance of a network depends on a number of factors, including the number of users, the type of transmission medium, the capabilities of the connected hardware, and the efficiency of the software.

### **Reliability:**

Network reliability is measured by the frequency of failure, the time it takes a link to recover from a failure, and the network's robustness in a catastrophe.

### **Security:**

Network security issues include protecting data from unauthorized access, protecting data from damage and development, and implementing policies and procedures for recovery from breaches and data losses.

# **PHYSICAL STRUCTURES**

**TYPES OF CONNECTIONS:** A network is two or more devices connected through links. A link is a communications pathway that transfers data from one device to another. There are two possible types of connections: point-to-point and multipoint.

## Point-to-Point

A point-to-point connection provides a dedicated link between two devices. The entire capacity of the link is reserved for transmission between those two devices. Most point-to-point connections use an actual length of wire or cable to connect the two ends, but other options, such as microwave or satellite links, are also possible. When you change television channels by infrared remote control, you are establishing a point-to-point connection between the remote control and the television's control system.

## Multipoint

A multipoint (also called multidrop) connection is one in which more than two specific devices share a single link. In a multipoint environment, the capacity of the channel is shared, either spatially or temporally. If several devices can use the link simultaneously, it is a *spatially shared* connection. If users must take turns, it is a *timeshared* connection.

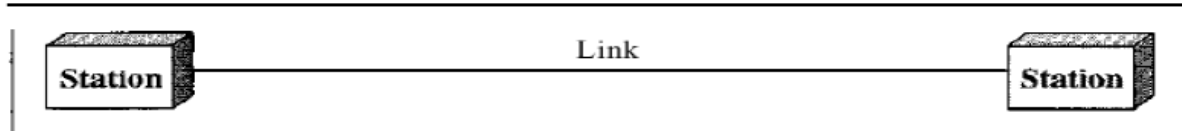

a. Point-to-point

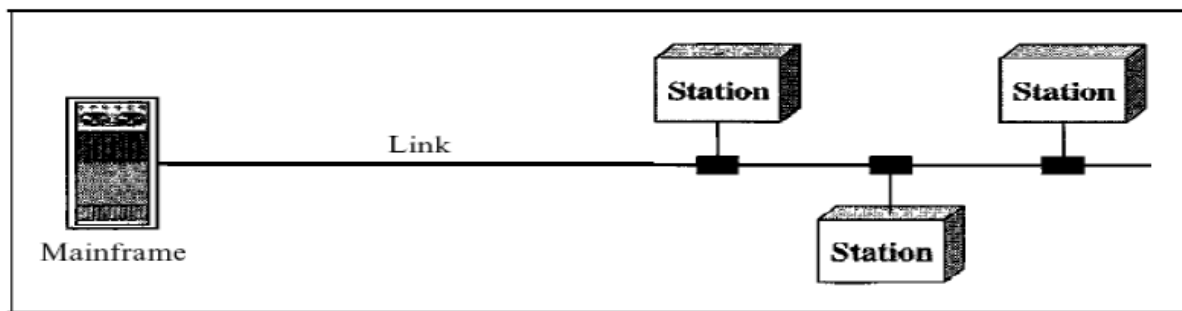

b. Multipoint

## **PHYSICAL TOPOLOGY:**

The term *physical topology* refers to the way in which a network is laid out physically. One or more devices connect to a link; two or more links form a topology. The topology of a network is the geometric representation of the relationship of all the links and linking devices (usually called nodes) to one another. There are four basic topologies possible: mesh, star, bus, and ring.

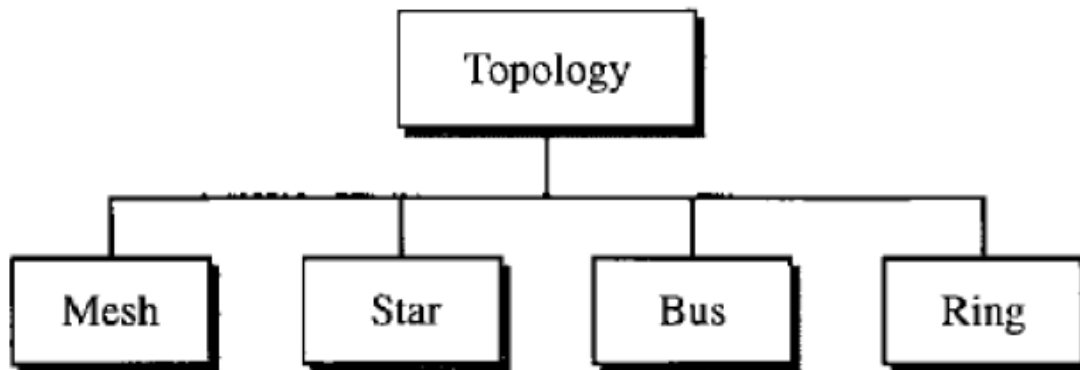

1. **Mesh:** In a mesh topology, every device has a dedicated point-to-point link to every other device. The term *dedicated* means that the link carries traffic only between the two devices it connects. To find the number of physical links in a fully connected mesh network with  $n$  nodes, we first consider that each node must be connected to every other node. Node 1 must be connected to  $n - 1$  nodes, node 2 must be connected to  $n - 1$  nodes, and finally node  $n$  must be connected to  $n - 1$  nodes. We need  $n(n - 1)$  physical links. However, if each physical link allows communication in both directions (duplex mode), we can divide the number of links by 2. In other words, we can say that in a mesh topology, we need  $n(n - 1) / 2$  duplex-mode links. To accommodate that many links, every device on the network must have  $n - 1$  input/output ports to be connected to the other  $n - 1$  stations.

### **Advantages:**

1. The use of dedicated links guarantees that each connection can carry its own data load, thus eliminating the traffic problems that can occur when links must be shared by multiple devices.
2. A mesh topology is robust. If one link becomes unusable, it does not incapacitate the entire system.

3. There is the advantage of privacy or security. When every message travels along a dedicated line, only the intended recipient sees it. Physical boundaries prevent other users from gaining access to messages.

4. Point-to-point links make fault identification and fault isolation easy. Traffic can be routed to avoid links with suspected problems. This facility enables the network manager to discover the precise location of the fault and aids in finding its cause and solution.

### **Disadvantages:**

1. Disadvantage of a mesh are related to the amount of cabling because every device must be connected to every other device.

2. Installation and reconnection are difficult.

3. The sheer bulk of the wiring can be greater than the available space (in walls, ceilings, or floors) can accommodate.

4. The hardware required to connect each link (I/O ports and cable) can be prohibitively expensive.

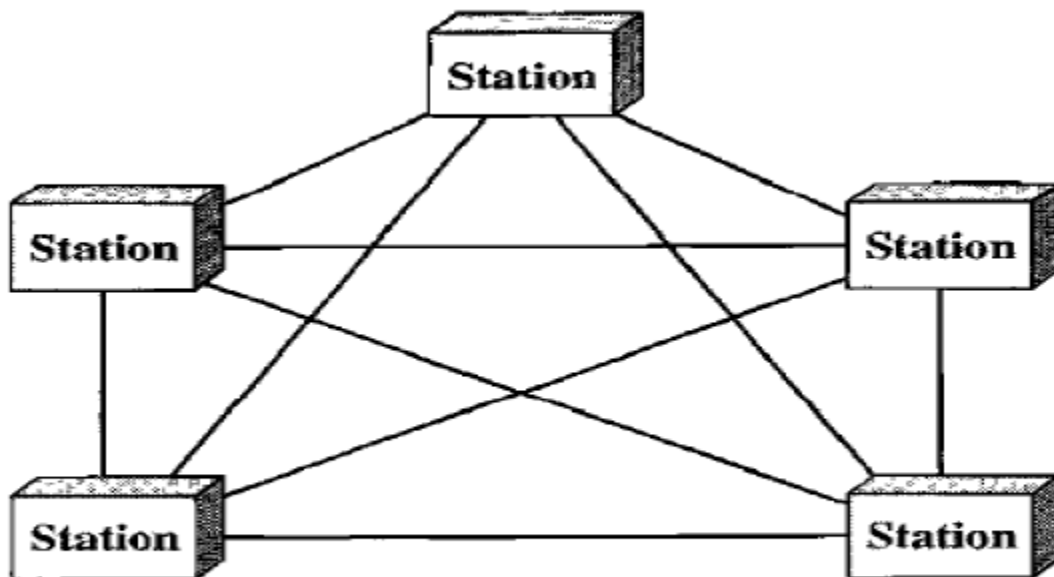



**2. Star Topology:** In a star topology, each device has a dedicated point-to-point link only to a central controller, usually called a hub. The devices are not directly linked to one another. Unlike a mesh topology, a star topology does not allow direct traffic between devices. The controller acts as an exchange: If one device wants to send data to another, it sends the data to the controller, which then relays the data to the other connected device .

**Advantages:**

1. A star topology is less expensive than a mesh topology. In a star, each device needs only one link and one I/O port to connect it to any number of others.
2. Easy to install and reconfigure.
3. Far less cabling needs to be housed, and additions, moves, and deletions involve only one connection: between that device and the hub.
4. Other advantage include robustness. If one link fails, only that link is affected. All other links remain active. This factor also lends itself to easy fault identification and fault isolation. As long as the hub is working, it can be used to monitor link problems and bypass defective links.

**Disadvantages:**

One big disadvantage of a star topology is the dependency of the whole topology on one single point, the hub. If the hub goes down, the whole system is dead. Although a star requires far less cable than a mesh, each node must be linked to a central hub. For this reason, often more cabling is required in a star than in some other topologies (such as ring or bus).

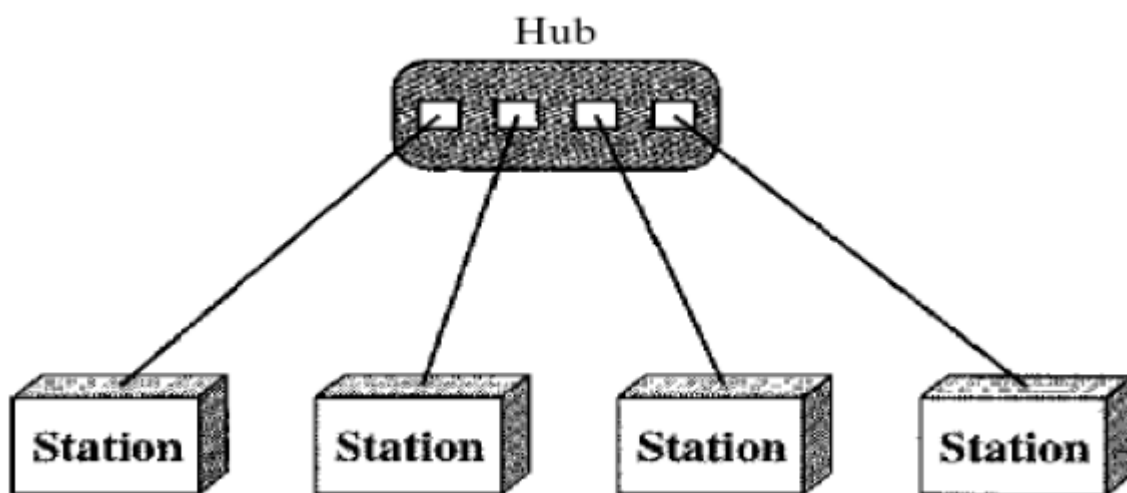

**3. BUS:** A bus topology is multipoint. One long cable acts as a **backbone** to link all the devices in a network. Nodes are connected to the bus cable by drop lines and taps. A drop line is a connection running between the device and the main cable. A tap is a connector that either splices into the main cable or punctures the sheathing of a cable to create a contact with the metallic core. As a signal travels along the backbone, some of its energy is transformed into heat. Therefore, it becomes weaker and weaker as it travels farther and farther. For this reason there is a limit on the number of taps a bus can support and on the distance between those taps.

**Advantages:**

Advantages of a bus topology include ease of installation. Backbone cable can be laid along the most efficient path, then connected to the nodes by drop lines of various lengths. In this way, a bus uses less cabling than mesh or star topologies. In a star, for example, four network devices in the same room require four lengths of cable reaching all the way to the hub. In a bus, this redundancy is eliminated. Only the backbone cable stretches through the entire facility. Each drop line has to reach only as far as the nearest point on the backbone.

**Disadvantages:**

Disadvantages include difficult reconnection and fault isolation. A bus is usually designed to be optimally efficient at installation. It can therefore be difficult to add new devices. Signal reflection at the taps can cause degradation in quality. This degradation can be controlled by limiting the number and spacing of devices connected to a given length of cable. Adding new devices may therefore require modification or replacement of the backbone. In addition, a fault or break in the bus cable stops all transmission, even between devices on the same side of the problem. The damaged area reflects signals back in the direction of origin, creating noise in both directions.

---

*A bus topology connecting three stations*

---

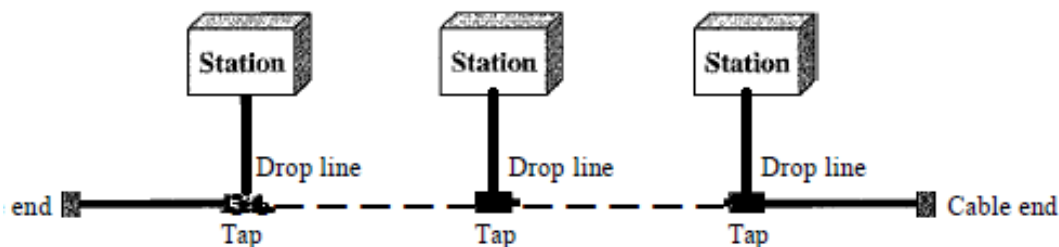

**4. RING:** In a ring topology, each device has a dedicated point-to-point connection with only the two devices on either side of it. A signal is passed along the ring in one direction, from device to device, until it reaches its destination. Each device in the ring incorporates a repeater. When a device receives a signal intended for another device, its repeater regenerates the bits and passes them along.

**Advantages:**

A ring is relatively easy to install and reconfigure. Each device is linked to only its immediate neighbors (either physically or logically). To add or delete a device requires changing only two connections. The only constraints are media and traffic considerations (maximum ring length and number of devices). In addition, fault isolation is simplified. Generally in a ring, a signal is circulating at all times. If one device does not receive a signal within a specified period, it can issue an alarm. The alarm alerts the network operator to the problem and its location.

**Disadvantages:**

Unidirectional traffic can be a disadvantage. In a simple ring, a break in the ring (such as a disabled station) can disable the entire network. This weakness can be solved by using a dual ring or a switch capable of closing off the break. Ring topology was prevalent when IBM introduced its local-area network Token Ring. Today, the need for higher-speed LANs has made this topology less popular.

---

Figure 1.8 *A ring topology connecting six stations*

---

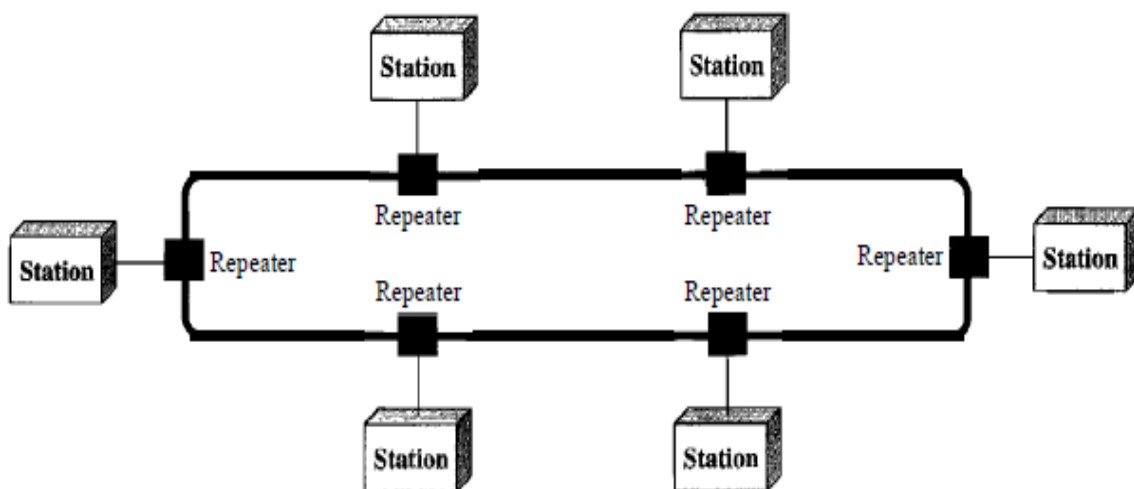

## **NETWORK CATEGORIES**

### **Local Area Networks (LAN):**

Local area networks, generally called LANs, are privately-owned networks within a single building or campus of up to a few kilometers in size. They are widely used to connect personal computers and workstations in company offices and factories to share resources (e.g., printers) and exchange information. LANs are distinguished from other kinds of networks by three characteristics:

- (1) Their size,
- (2) Their transmission technology, and
- (3) Their topology.

LANs are restricted in size, which means that the worst-case transmission time is bounded and known in advance. Knowing this bound makes it possible to use certain kinds of designs that would not otherwise be possible. It also simplifies network management. LANs may use a transmission technology consisting of a cable to which all the machines are attached, like the telephone company party lines once used in rural areas. Traditional LANs run at speeds of 10 Mbps to 100 Mbps, have low delay (microseconds or nanoseconds), and make very few errors. Newer LANs operate at up to 10 Gbps.

### **Metropolitan Area Network (MAN):**

A metropolitan area network, or MAN, covers a city. The best-known example of a MAN is the cable television network available in many cities. This system grew from earlier community antenna systems used in areas with poor over-the-air television reception. In these early systems, a large antenna was placed on top of a nearby hill and signal was then piped to the subscribers' houses. At first, these were locally-designed, ad hoc systems. Then companies began jumping into the business, getting contracts from city governments to wire up an entire city. The next step was television programming and even entire channels designed for cable only. Often these channels were highly specialized, such as all news, all sports, all cooking, all gardening, and so on. But from their inception until the late 1990s, they were intended for television reception only. Cable television is not the only MAN. Recent developments in high-speed wireless Internet access resulted in another MAN, which has been standardized as IEEE 802.16.

### **Wide Area Network (WAN):**

A wide area network, or WAN, spans a large geographical area, often a country or continent. It contains a collection of machines intended for running user (i.e., application) programs. These

machines are called as hosts. The hosts are connected by a communication subnet, or just subnet for short. The hosts are owned by the customers (e.g., people's personal computers), whereas the communication subnet is typically owned and operated by a telephone company or Internet service provider. The job of the subnet is to carry messages from host to host, just as the telephone system carries words from speaker to listener. Separation of the pure communication aspects of the network (the subnet) from the application aspects (the hosts), greatly simplifies the complete network design. In most wide area networks, the subnet consists of two distinct components: transmission lines and switching elements. Transmission lines move bits between machines. They can be made of copper wire, optical fiber, or even radio links. In most WANs, the network contains numerous transmission lines, each one connecting a pair of routers. If two routers that do not share a transmission line wish to communicate, they must do this indirectly, via other routers. When a packet is sent from one router to another via one or more intermediate routers, the packet is received at each intermediate router in its entirety, stored there until the required output line is free, and then forwarded. A subnet organized according to this principle is called a store-and-forward or packet-switched subnet. Nearly all wide area networks (except those using satellites) have store-and-forward subnets. When the packets are small and all the same size, they are often called cells. The principle of a packet-switched WAN is so important. Generally, when a process on some host has a message to be sent to a process on some other host, the sending host first cuts the message into packets, each one bearing its number in the sequence. These packets are then injected into the network one at a time in quick succession. The packets are transported individually over the network and deposited at the receiving host, where they are reassembled into the original message and delivered to the receiving process. Not all WANs are packet switched. A second possibility for a WAN is a satellite system. Each router has an antenna through which it can send and receive. All routers can hear the output from the satellite, and in some cases they can also hear the upward transmissions of their fellow routers to the satellite as well. Sometimes the routers are connected to a substantial point-to-point subnet, with only some of them having a satellite antenna. Satellite networks are inherently broadcast and are most useful when the broadcast property is important.

## **ANALOG AND DIGITAL**

**Analog Data:** The term **analog data** refers to information that is continuous; For example, an analog clock that has hour, minute, and second hands gives information in a continuous form; the

movements of the hands are continuous. Analog data, such as the sounds made by a human voice, take on continuous values. When someone speaks, an analog wave is created in the air. This can be captured by a microphone and converted to an analog signal or sampled and converted to a digital signal.

### **Digital Data:**

**Digital data** refers to information that has discrete states. For example, a digital clock that reports the hours and the minutes will change suddenly from 8:05 to 8:06. Digital data takes on discrete values. For example, data are stored in computer memory in the form of 0s and 1s. They can be converted to a digital signal or modulated into an analog signal for transmission across a medium.

### **Analog and Digital Signals:**

Like the data they represent, signals can be either analog or digital. An analog signal has infinitely many levels of intensity over a period of time. As the wave moves from value *A* to value *B*, it passes through and includes an infinite number of values along its path. A digital signal, on the other hand, can have only a limited number of defined values. Although each value can be any number, it is often as simple as 1 and 0. The simplest way to show signals is by plotting them on a pair of perpendicular axes. The vertical axis represents the value or strength of a signal. The horizontal axis represents time. Figure below illustrates an analog signal and a digital signal. The curve representing the analog signal passes through an infinite number of points. The vertical lines of the digital signal, however, demonstrate the sudden jump that the signal makes from value to value.

---

**Figure 3.1** *Comparison of analog and digital signals*

---

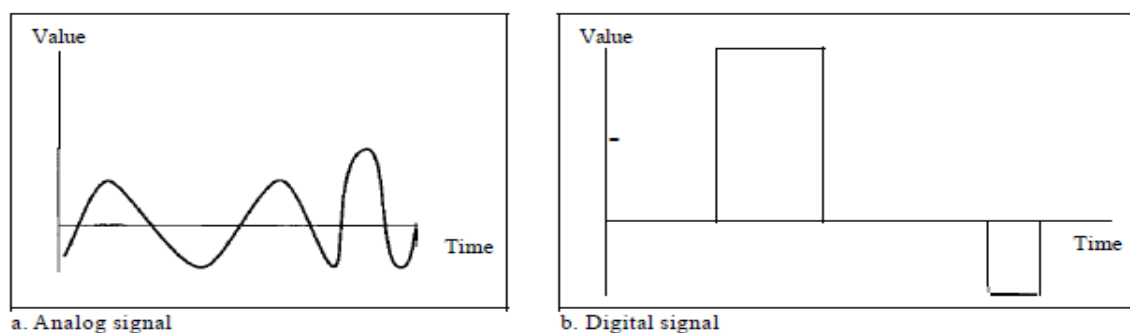

### **Periodic and Nonperiodic Signals:**

A periodic signal completes a pattern within a measurable time frame, called a period, and repeats that pattern over subsequent identical periods. The completion of one full pattern is called a cycle. A nonperiodic signal changes without exhibiting a pattern or cycle that repeats over time.

### **PERIODIC ANALOG SIGNALS:**

Periodic analog signals can be classified as simple or composite. A simple periodic analog signal, a sine wave, cannot be decomposed into simpler signals. A composite periodic analog signal is composed of multiple sine waves.

### **Sine Wave**

The sine wave is the most fundamental form of a periodic analog signal. When we visualize it as a simple oscillating curve, its change over the course of a cycle is smooth and consistent, a continuous, rolling flow. Figure below shows a sine wave. Each cycle consists of a single arc above the time axis followed by a single arc below it.

---

*A sine wave*

---

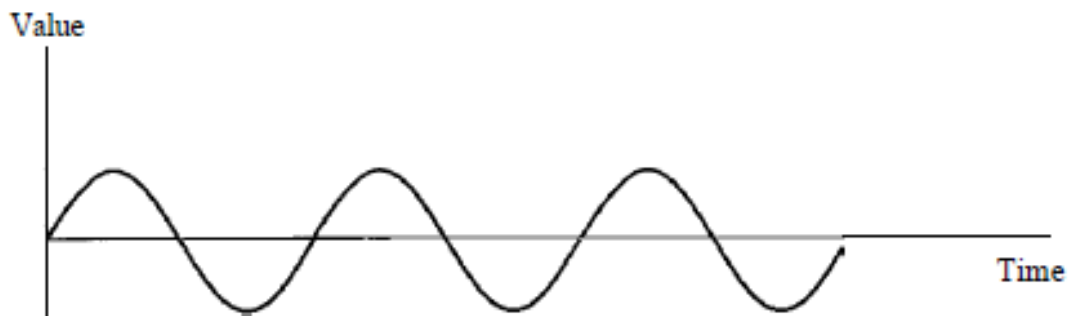

---

### **Characteristics of Signals:**

#### **1. Peak Amplitude**

The peak amplitude of a signal is the absolute value of its highest intensity, proportional to the energy it carries. For electric signals, peak amplitude is normally measured in *volts*. Figure below shows two signals and their peak amplitudes.

---

*Two signals with the same phase and frequency, but different amplitudes*

---

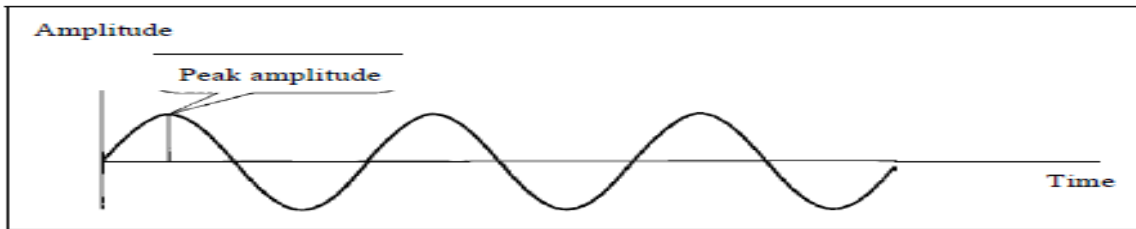

a. A signal with high peak amplitude

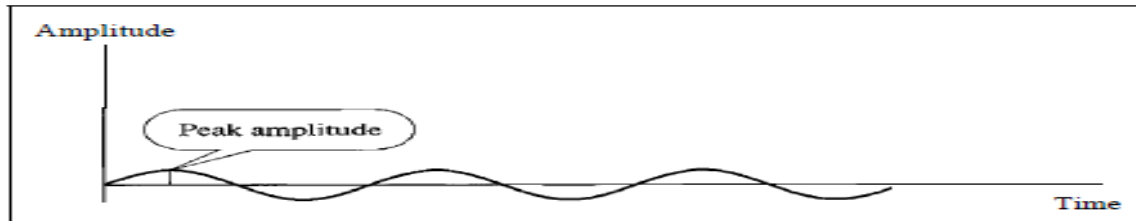

b. A signal with low peak amplitude

---

## **2. Period and Frequency**

Period refers to the amount of time, in seconds, a signal needs to complete 1 cycle.

Frequency refers to the number of periods in 1 s. Note that period and frequency are just one characteristic defined in two ways. Period is the inverse of frequency, and frequency is the inverse of period, as the following formulas show.

$$f=1/T \quad \text{and} \quad T=1/f$$

Period is formally expressed in seconds. Frequency is formally expressed in Hertz (Hz), which is cycle per second.

---

*Two signals with the same amplitude and phase, but different frequencies*

---

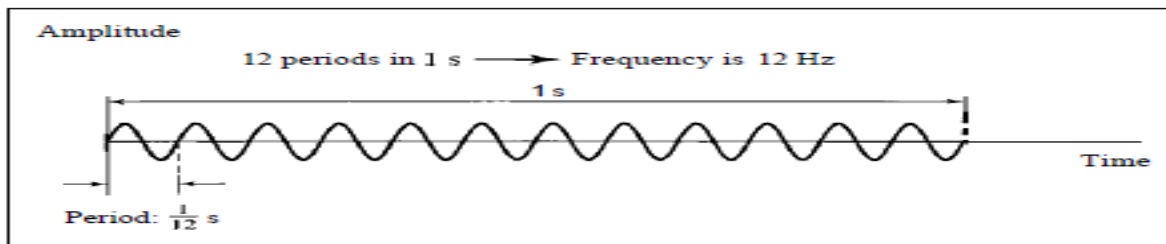

a. A signal with a frequency of 12 Hz

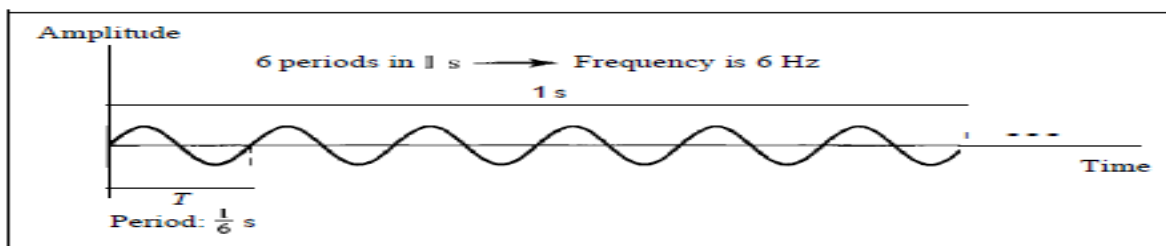

b. A signal with a frequency of 6 Hz

---



### 3. Phase

The term phase describes the position of the waveform relative to time 0. If we think of the wave as something that can be shifted backward or forward along the time axis, phase describes the amount of that shift. It indicates the status of the first cycle. Phase is measured in degrees or radians [ $360^\circ$  is  $2\pi$  rad;  $1^\circ$  is  $2\pi/360$  rad, and 1 rad is  $360/(2\pi)$ ]. A phase shift of  $360^\circ$  corresponds to a shift of a complete period; a phase shift of  $180^\circ$  corresponds to a shift of one-half of a period; and a phase shift of  $90^\circ$  corresponds to a shift of one-quarter of a period.

*Three sine waves with the same amplitude and frequency, but different phases*

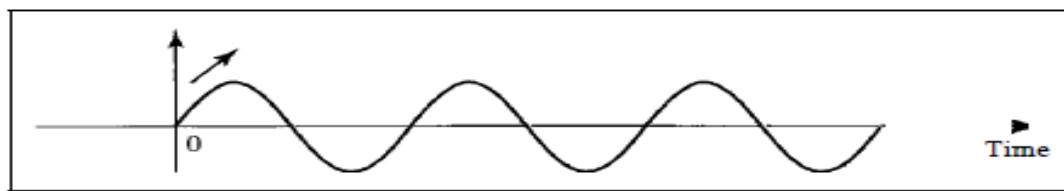

a. 0 degrees

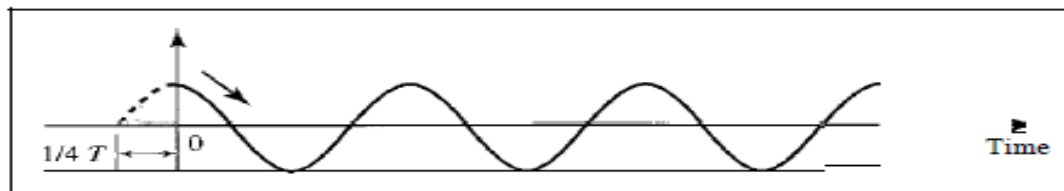

b. 90 degrees

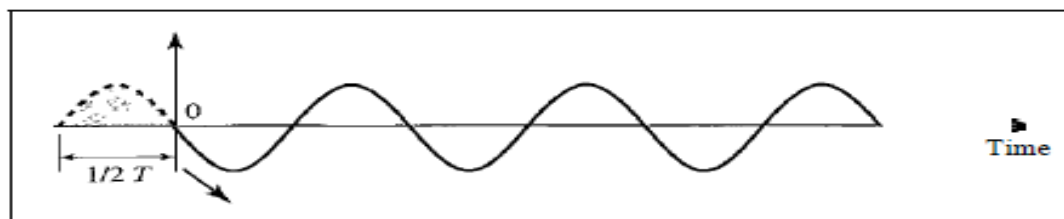

c. 180 degrees

- I. A sine wave with a phase of  $0^\circ$  starts at time 0 with a zero amplitude. The amplitude is increasing.
- II. A sine wave with a phase of  $90^\circ$  starts at time 0 with a peak amplitude. The amplitude is decreasing.
- III. A sine wave with a phase of  $180^\circ$  starts at time 0 with a zero amplitude. The amplitude is decreasing.

#### 4. Wavelength

Wavelength is another characteristic of a signal traveling through a transmission medium. Wavelength binds the period or the frequency of a simple sine wave to the propagation speed of the medium. While the frequency of a signal is independent of the medium, the wavelength depends on both the frequency and the medium. Wavelength is a property of any type of signal. In data communications, we often use wavelength to describe the transmission of light in an optical fiber. The wavelength is the distance a simple signal can travel in one period. Wavelength can be calculated if one is given the propagation speed (the speed of light) and the period of the signal. However, since period and frequency are related to each other, if we represent wavelength by  $\lambda$ , propagation speed by  $c$  (speed of light), and frequency by  $f$ , we get

Wavelength=Propagation speed \* Period = propagation speed/frequency

$$\lambda=c/f$$

The wavelength is normally measured in micrometers (microns) instead of meters.

#### Bandwidth

The range of frequencies contained in a composite signal is its bandwidth. The bandwidth is normally a difference between two numbers. For example, if a composite signal contains frequencies between 1000 and 5000, its bandwidth is 5000 - 1000, or 4000. Figure 3.12 shows the concept of bandwidth. The figure depicts two composite signals, one periodic and the other nonperiodic. The bandwidth of the periodic signal contains all integer frequencies between 1000 and 5000 (1000, 1001, 1002, ...). The bandwidth of the nonperiodic signals has the same range, but the frequencies are continuous.

Figure 3.12 *The bandwidth of periodic and nonperiodic composite signals*

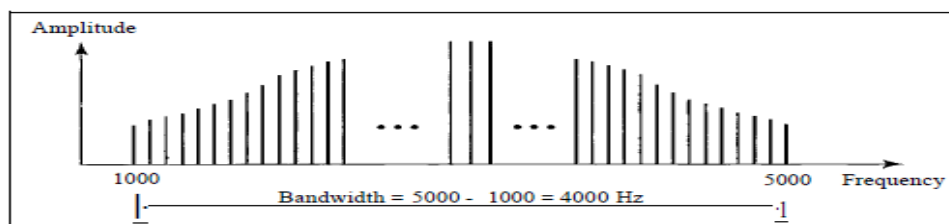

a. Bandwidth of a periodic signal

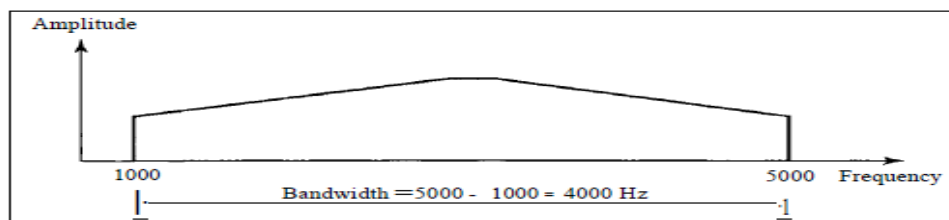

b. Bandwidth of a nonperiodic signal

## DIGITAL SIGNALS

In addition to being represented by an analog signal, information can also be represented by a digital signal. For example, a 1 can be encoded as a positive voltage and a 0 as zero voltage. A digital signal can have more than two levels. In this case, we can send more than 1 bit for each level. Figure 3.16 shows two signals, one with two levels and the other with four.

Figure 3.16 Two digital signals: one with two signal levels and the other with four signal levels

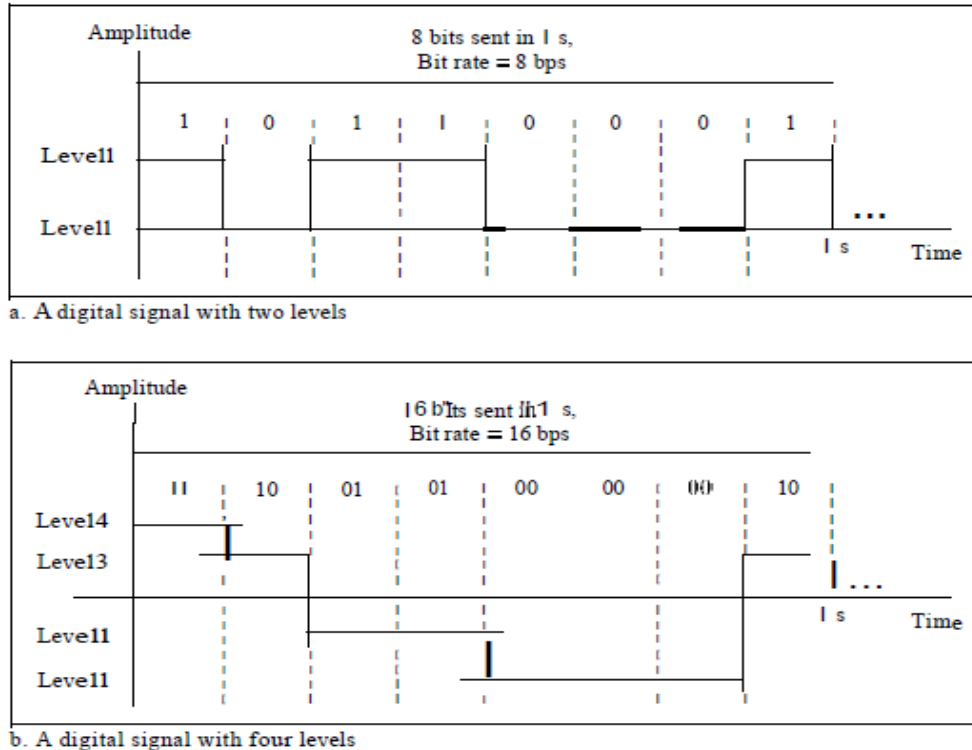

a. A digital signal with two levels

b. A digital signal with four levels

We send 1 bit per level in part a of the figure and 2 bits per level in part b of the figure. In general, if a signal has  $L$  levels, each level needs  $\log_2 L$  bits.

### Bit Rate

Most digital signals are nonperiodic, and thus period and frequency are not appropriate characteristics. Another term-bit rate is used to describe digital signals. The bit rate is the number of bits sent in 1s, expressed in bits per second (bps). Figure 3.16 shows the bit rate for two signals.

# TRANSMISSION IMPAIRMENT

Signals travel through transmission media, which are not perfect. The imperfection causes signal impairment. This means that the signal at the beginning of the medium is not the same as the signal at the end of the medium. What is sent is not what is received. Three causes of impairment are attenuation, distortion, and noise.

---

## *Causes of impairment*

---

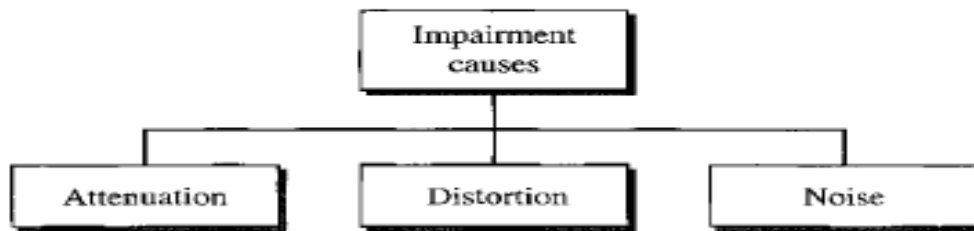

### **1. Attenuation**

Attenuation means a loss of energy. When a signal, simple or composite, travels through a medium, it loses some of its energy in overcoming the resistance of the medium. That is why a wire carrying electric signals gets warm, if not hot, after a while. Some of the electrical energy in the signal is converted to heat. To compensate for this loss, amplifiers are used to amplify the signal. Attenuation is measured in terms of Decibels.

The decibel (dB) measures the relative strengths of two signals or one signal at two different points. Note that the decibel is negative if a signal is attenuated and positive if a signal is amplified.

$$\text{dB} = 10 \log_{10} P_2/P_1$$

Variables  $P_1$  and  $P_2$  are the powers of a signal at points 1 and 2, respectively.

### **2. Distortion:**

Distortion means that the signal changes its form or shape. Distortion can occur in a composite signal made of different frequencies. Each signal component has its own propagation speed through a medium and, therefore, its own delay in arriving at the final destination. Differences in delay may create a difference in phase if the delay is not exactly the same as the period duration. In other words, signal components at the receiver have phases different from what they had at the

sender. The shape of the composite signal is therefore not the same. Figure 3.28 shows the effect of distortion on a composite signal.

**Figure 3.28** *Distortion*

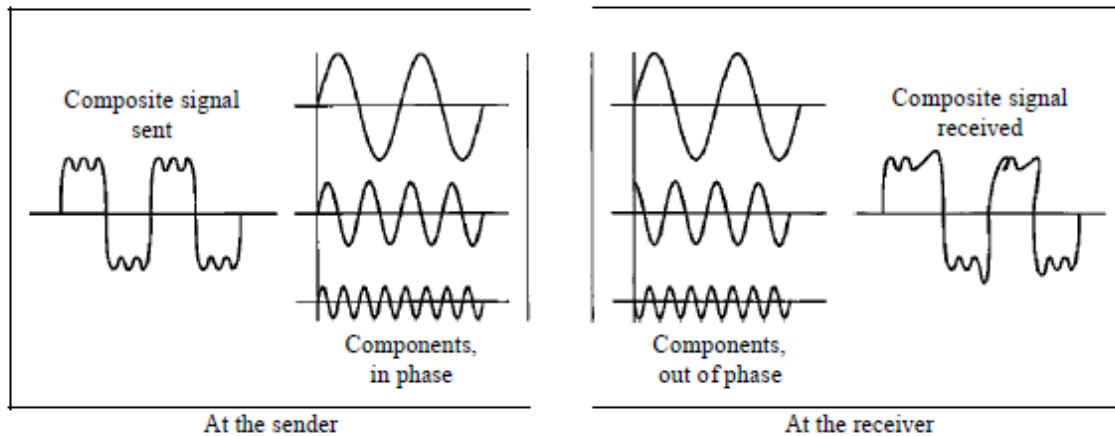

### 3. Noise

Noise is another cause of impairment. Several types of noise, such as thermal noise, induced noise, crosstalk, and impulse noise, may corrupt the signal. Thermal noise is the random motion of electrons in a wire which creates an extra signal not originally sent by the transmitter. Induced noise comes from sources such as motors and appliances. These devices act as a sending antenna, and the transmission medium acts as the receiving antenna. Crosstalk is the effect of one wire on the other. One wire acts as a sending antenna and the other as the receiving antenna. Impulse noise is a spike (a signal with high energy in a very short time) that comes from power lines, lightning, and so on.

#### Signal-to-Noise Ratio (SNR)

The signal-to-noise ratio is defined as

$$\text{SNR} = \text{Average Signal power} / \text{Average Noise Power}$$

SNR is actually the ratio of what is wanted (signal) to what is not wanted (noise). A high SNR means the signal is less corrupted by noise; a low SNR means the signal is more corrupted by noise. Because SNR is the ratio of two powers, it is often described in decibel units, SNR dB, defined as

$$\text{SNRdB} = 10 \log_{10} \text{SNR}$$

## DATA RATE LIMITS

A very important consideration in data communications is how fast we can send data, in bits per second, over a channel. Data rate depends on three factors:

1. The bandwidth available
2. The level of the signals we use
3. The quality of the channel (the level of noise)

Two theoretical formulas were developed to calculate the data rate: one by **Nyquist** for a noiseless channel, another by **Shannon** for a noisy channel.

### Noiseless Channel: Nyquist Bit Rate

For a noiseless channel, the Nyquist bit rate formula defines the theoretical maximum bit rate

$$\text{BitRate} = 2 \times \text{bandwidth} \times \log_2 L$$

In this formula, bandwidth is the bandwidth of the channel,  $L$  is the number of signal levels used to represent data, and BitRate is the bit rate in bits per second. According to the formula, we might think that, given a specific bandwidth, we can have any bit rate we want by increasing the number of signal levels. Although the idea is theoretically correct, practically there is a limit. When we increase the number of signal levels, we impose a burden on the receiver. If the number of levels in a signal is just 2, the receiver can easily distinguish between a 0 and a 1. If the level of a signal is 64, the receiver must be very sophisticated to distinguish between 64 different levels. In other words, increasing the levels of a signal reduces the reliability of the system.

### Noisy Channel: Shannon Capacity

In reality, we cannot have a noiseless channel; the channel is always noisy. In 1944, Claude Shannon introduced a formula, called the Shannon capacity, to determine the theoretical highest data rate for a noisy channel:

$$\text{Capacity} = \text{bandwidth} \times \log_2 (1 + \text{SNR})$$

In this formula, bandwidth is the bandwidth of the channel, SNR is the signal-to-noise ratio, and capacity is the capacity of the channel in bits per second. Note that in the Shannon formula there is no indication of the signal level, which means that no matter how many levels we have, we cannot achieve a data rate higher than the capacity of the channel. In other words, the formula defines a characteristic of the channel, not the method of transmission.

### Bandwidth in Bits per Seconds

The term *bandwidth* can also refer to the number of bits per second that a channel, a link, or even a network can transmit. For example, one can say the bandwidth of a Fast Ethernet network is a maximum of 100 Mbps. This means that this network can send 100 Mbps.

## DIGITAL-TO-ANALOG CONVERSION

**Digital-to-analog conversion** is the process of changing one of the characteristics of an analog signal based on the information in digital data. Figure 5.1 shows the relationship between the digital information, the digital-to-analog modulating process, and the resultant analog signal.

**Figure 5.1** *Digital-to-analog conversion*

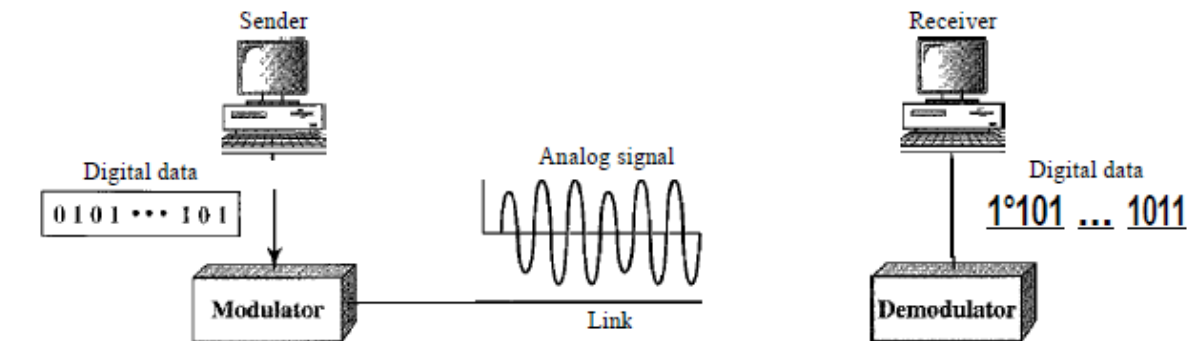

A sine wave is defined by three characteristics: amplitude, frequency, and phase. When we vary anyone of these characteristics, we create a different version of that wave. So, by changing one characteristic of a simple electric signal, we can use it to represent digital data. Any of the three characteristics can be altered in this way, giving us at least three mechanisms for modulating digital data into an analog signal: amplitude shift keying (ASK), frequency shift keying (FSK), and phase shift keying (PSK).

### Aspects of Digital-to-Analog Conversion

Before we discuss specific methods of digital-to-analog modulation, two basic issues must be reviewed: bit and baud rates and the carrier signal.

### Data Element Versus Signal Element

Data element as the smallest piece of information to be exchanged, the bit. We also defined a signal element as the smallest unit of a signal that is constant.

### Data Rate Versus Signal Rate

We can define the data rate (bit rate) and the signal rate (baud rate). The relationship between them is

$$S = N/r \text{ baud}$$

where  $N$  is the data rate (bps) and  $r$  is the number of data elements carried in one signal element. The value of  $r$  in analog transmission is  $r = \log_2 L$ , where  $L$  is the type of signal element, not the level.

### Carrier Signal

In analog transmission, the sending device produces a high-frequency signal that acts as a base for the information signal. This base signal is called the carrier signal or carrier frequency. The receiving device is tuned to the frequency of the carrier signal that it expects from the sender. Digital information then changes the carrier signal by modifying one or more of its characteristics (amplitude, frequency, or phase). This kind of modification is called modulation (shift keying).

### 1. Amplitude Shift Keying (ASK)

In amplitude shift keying, the amplitude of the carrier signal is varied to create signal elements. Both frequency and phase remain constant while the amplitude changes. Although we can have several levels (kinds) of signal elements, each with a different amplitude, ASK is normally implemented using only two levels. This is referred to as binary amplitude shift keying or *on-off keying* (OOK). The peak amplitude of one signal level is 0; the other is the same as the amplitude of the carrier frequency. Figure 5.3 gives a conceptual view of binary ASK.

Figure 5.3 Binary amplitude shift keying

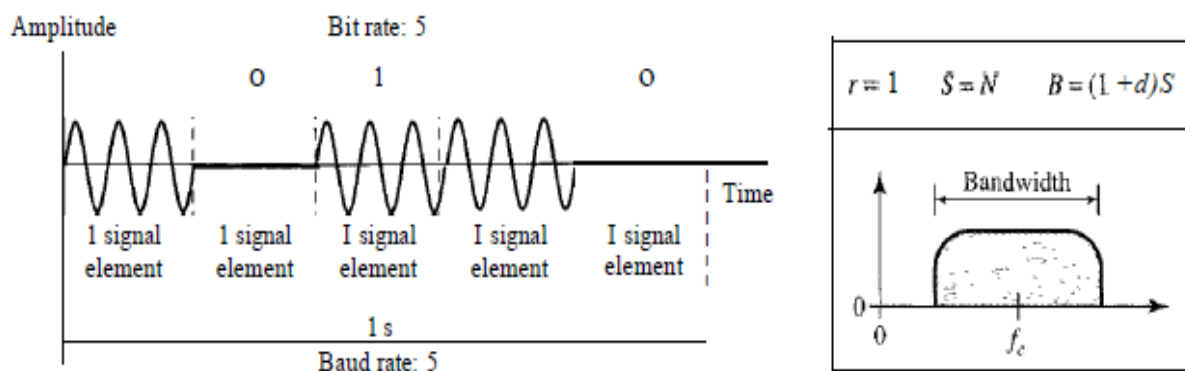



## 2. Frequency Shift Keying (FSK)

In frequency shift keying, the frequency of the carrier signal is varied to represent data. The frequency of the modulated signal is constant for the duration of one signal element, but changes for the next signal element if the data element changes. Both peak amplitude and phase remain constant for all signal elements.

One way to think about binary FSK (or BFSK) is to consider two carrier frequencies. In Figure 5.6, we have selected two carrier frequencies,  $f_1$  and  $f_2$ . We use the first carrier if the data element is 0; we use the second if the data element is 1. However, note that this is an unrealistic example used only for demonstration purposes. Normally the carrier frequencies are very high, and the difference between them is very small.

Figure 5.6 Binary frequency shift keying

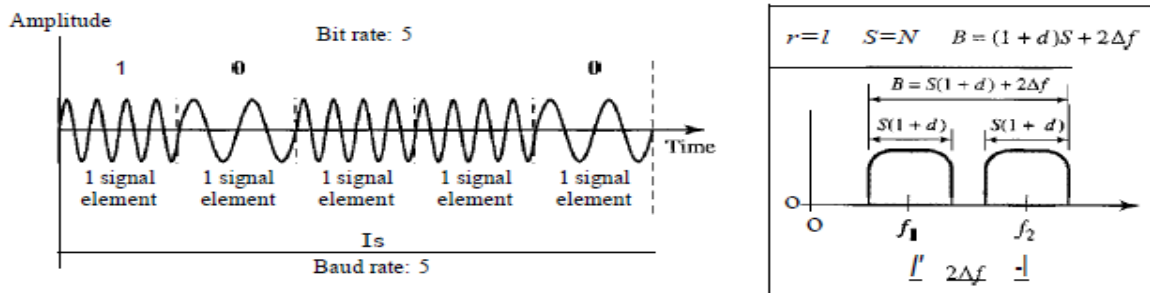

## 3. Phase Shift Keying (PSK)

In phase shift keying, the phase of the carrier is varied to represent two or more different signal elements. Both peak amplitude and frequency remain constant as the phase changes. Today, PSK is more common than ASK or FSK. The simplest PSK is binary PSK, in which we have only two signal elements, one with a phase of  $0^\circ$ , and the other with a phase of  $180^\circ$ . Figure 5.9 gives a conceptual view of PSK.

Figure 5.9 Binary phase shift keying

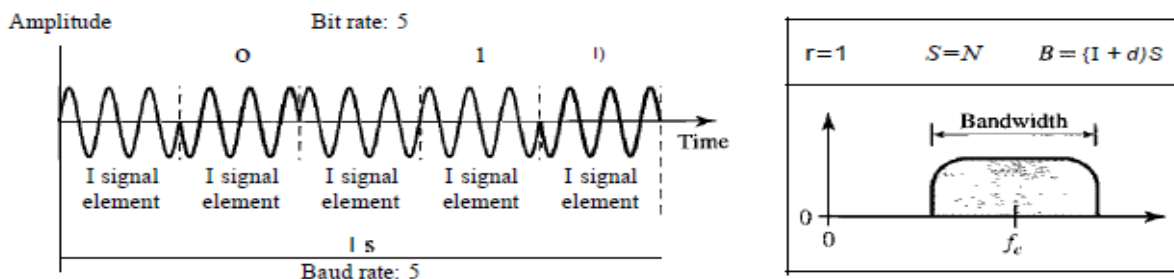

## MULTIPLEXING

Whenever the bandwidth of a medium linking two devices is greater than the bandwidth needs of the devices, the link can be shared. Multiplexing is the set of techniques that allows the simultaneous transmission of multiple signals across a single data link.

In a multiplexed system,  $n$  lines share the bandwidth of one link. Figure 6.1 shows the basic format of a multiplexed system. The lines on the left direct their transmission streams to a multiplexer (MUX), which combines them into a single stream (many-to-one). At the receiving end, that stream is fed into a demultiplexer (DEMUX), which separates the stream back into its component transmissions (one-to-many) and directs them to their corresponding lines. In the figure, the word link refers to the physical path. The word channel refers to the portion of a link that carries a transmission between a given pair of lines. One link can have many ( $n$ ) channels.

---

**Figure 6.1** *Dividing a link into channels*

---

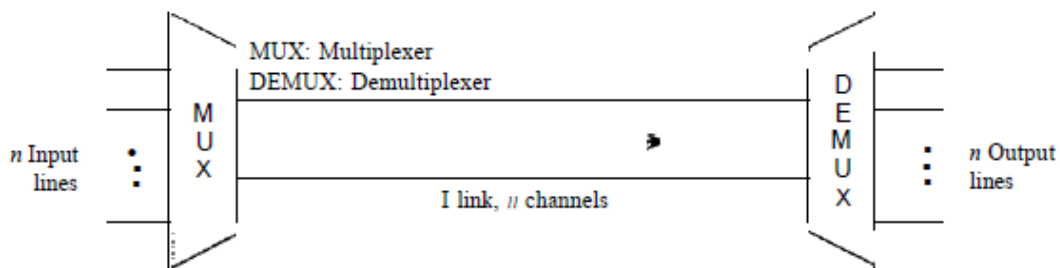

---

There are three basic multiplexing techniques: frequency-division multiplexing, wavelength-division multiplexing, and time-division multiplexing. The first two are techniques designed for analog signals, the third, for digital signals.

### **1. Frequency-Division Multiplexing**

Frequency-division multiplexing (FDM) is an analog technique that can be applied when the bandwidth of a link (in hertz) is greater than the combined bandwidths of the signals to be transmitted. In FDM, signals generated by each sending device modulate different carrier frequencies. These modulated signals are then combined into a single composite signal that can be transported by the link. Carrier frequencies are separated by sufficient bandwidth to accommodate the modulated signal. These bandwidth ranges are the channels through which the various signals travel. Channels can be separated by strips of unused bandwidth-guard bands-to

prevent signals from overlapping. In addition, carrier frequencies must not interfere with the original data frequencies.

### **Multiplexing Process**

Figure 6.4 is a conceptual illustration of the multiplexing process. Each source generates a signal of a similar frequency range. Inside the multiplexer, these similar signals modulates different carrier frequencies. The resulting modulated signals are then combined into a single composite signal that is sent out over a media link that has enough bandwidth to accommodate it.

**Figure 6.4** *FDM process*

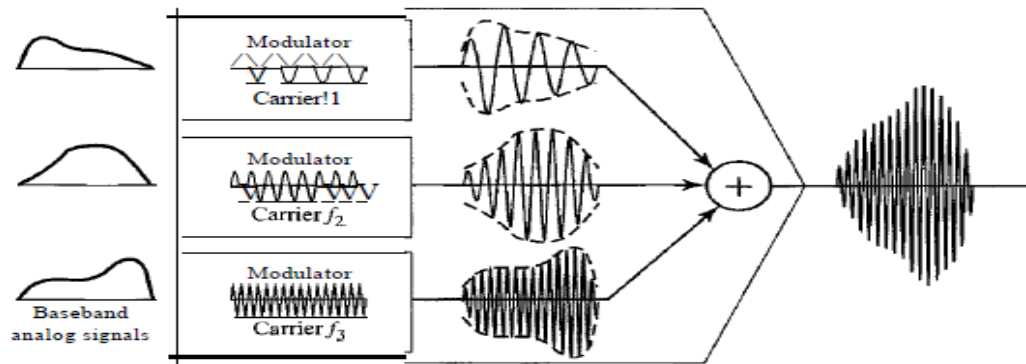

### **Demultiplexing Process**

The demultiplexer uses a series of filters to decompose the multiplexed signal into its constituent component signals. The individual signals are then passed to a demodulator that separates them from their carriers and passes them to the output lines. Figure 6.5 is a conceptual illustration of demultiplexing process.

**Figure 6.5** *FDM demultiplexing example*

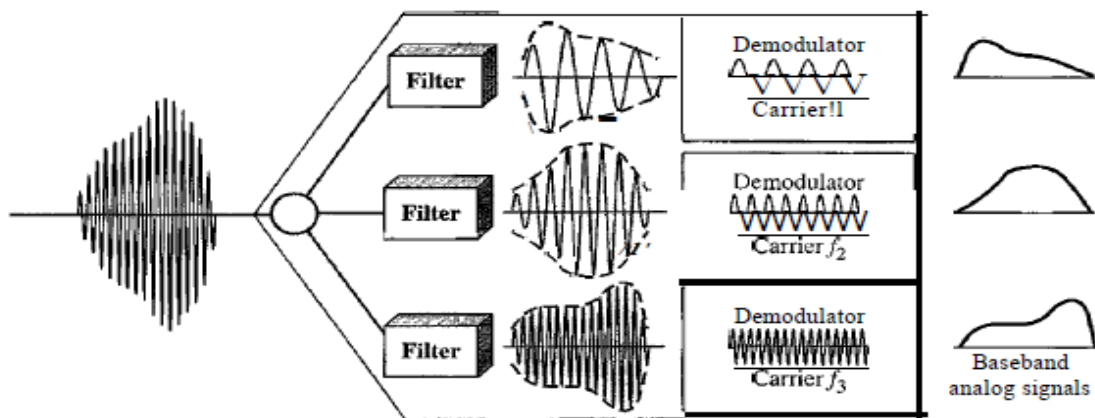

## 2. Wavelength-Division Multiplexing

Wavelength-division multiplexing (WDM) is designed to use the high-data-rate capability of fiber-optic cable. The optical fiber data rate is higher than the data rate of metallic transmission cable. Using a fiber-optic cable for one single line wastes the available bandwidth. Multiplexing allows us to combine several lines into one. WDM is conceptually the same as FDM, except that the multiplexing and demultiplexing involve optical signals transmitted through fiber-optic channels. The idea is the same: We are combining different signals of different frequencies. The difference is that the frequencies are very high. Figure 6.10 gives a conceptual view of a WDM multiplexer and demultiplexer. Very narrow bands of light from different sources are combined to make a wider band of light. At the receiver, the signals are separated by the demultiplexer.

**Figure 6.10** *Wavelength-division multiplexing*

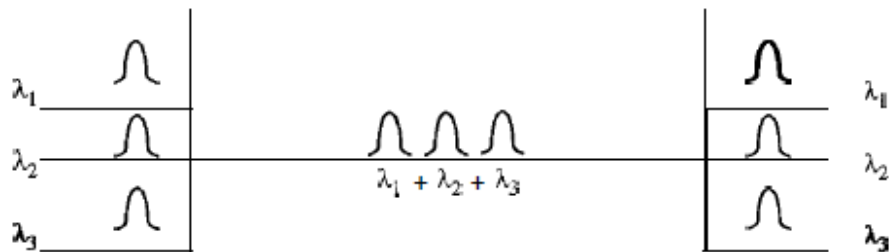

---

**WDM is an analog multiplexing technique to combine optical signals.**

---

Although WDM technology is very complex, the basic idea is very simple. We want to combine multiple light sources into one single light at the multiplexer and do the reverse at the demultiplexer. The combining and splitting of light sources are easily handled by a prism.

**Figure 6.11** *Prisms in wavelength-division multiplexing and demultiplexing*

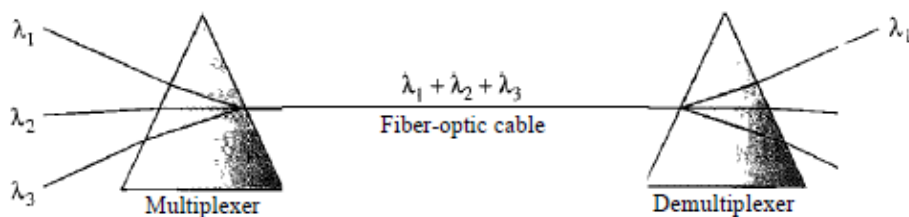

One application of WDM is the SONET network in which multiple optical fiber lines are multiplexed and demultiplexed.

### 3. Time-Division Multiplexing

Time-division multiplexing (TDM) is a digital process that allows several connections to share the high bandwidth of a line. Instead of sharing a portion of the bandwidth as in FDM, time is shared. Each connection occupies a portion of time in the link. Figure 6.12 gives a conceptual view of TDM. Note that the same link is used as in FDM; here, however, the link is shown sectioned by time rather than by frequency. In the figure, portions of signals 1,2,3, and 4 occupy the link sequentially.

Figure 6.12 TDM

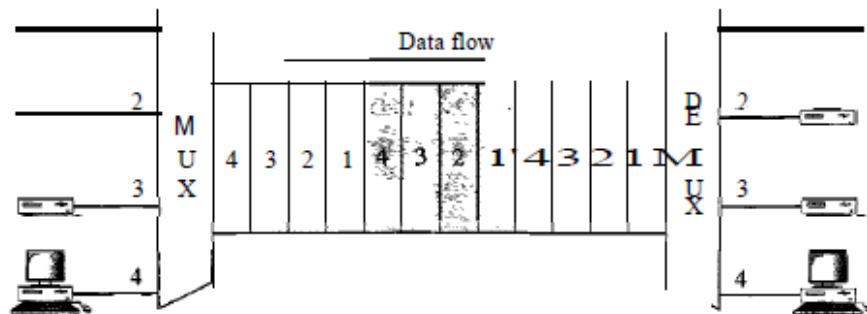

Note that in Figure 6.12 we are concerned with only multiplexing, not switching. This means that all the data in a message from source 1 always go to one specific destination, be it 1, 2, 3, or 4. The delivery is fixed and unvarying, unlike switching.

## TRANSMISSION MEDIA

A transmission **medium** can be broadly defined as anything that can carry information from a source to a destination. For example, the transmission medium for two people having a dinner conversation is the air. The air can also be used to convey the message in a smoke signal or semaphore. For a written message, the transmission medium might be a mail carrier, a truck, or an airplane.

In data communications the definition of the information and the transmission medium is more specific. The transmission medium is usually free space, metallic cable, or fiber-optic cable. The information is usually a signal that is the result of a conversion of data from another form.

## **Guided Media**

Guided media, which are those that provide a conduit from one device to another, include twisted-pair cable, coaxial cable, and fiber-optic cable. A signal traveling along any of these media is directed and contained by the physical limits of the medium. Twisted-pair and coaxial cable use metallic (copper) conductors that accept and transport signals in the form of electric current. Optical fiber is a cable that accepts and transports signals in the form of light.

### **1. Twisted-Pair Cable**

A twisted pair consists of two conductors (normally copper), each with its own plastic insulation, twisted together, as shown in Figure 7.3.

---

**Figure 7.3** *Twisted-pair cable*

---



One of the wires is used to carry signals to the receiver, and the other is used only as a ground reference. The receiver uses the difference between the two. In addition to the signal sent by the sender on one of the wires, interference (noise) and crosstalk may affect both wires and create unwanted signals. If the two wires are parallel, the effect of these unwanted signals is not the same in both wires because they are at different locations relative to the noise or crosstalk sources (e.g., one is closer and the other is farther). This results in a difference at the receiver. By twisting the pairs, a balance is maintained. For example, suppose in one twist, one wire is closer to the noise source and the other is farther; in the next twist, the reverse is true. Twisting makes it probable that both wires are equally affected by external influences (noise or crosstalk). This means that the receiver, which calculates the difference between the two, receives no unwanted signals. The unwanted signals are mostly canceled out. From the above discussion, it is clear that the number of twists per unit of length (e.g., inch) has some effect on the quality of the cable.

#### ***Applications***

Twisted-pair cables are used in telephone lines to provide voice and data channels. The local loop-the line that connects subscribers to the central telephone office-commonly consists of unshielded twisted-pair cables. The DSL lines that are used by the telephone companies to

provide high-data-rate connections also use the high-bandwidth capability of unshielded twisted-pair cables. Local-area networks, such as IOBase-T and IOOBBase-T, also use twisted-pair cables.

## 2. Coaxial Cable

Coaxial cable (or *coax*) carries signals of higher frequency ranges than those in twisted pair cable, in part because the two media are constructed quite differently. Instead of having two wires, coax has a central core conductor of solid or stranded wire (usually copper) enclosed in an insulating sheath, which is, in turn, encased in an outer conductor of metal foil, braid, or a combination of the two. The outer metallic wrapping serves both as a shield against noise and as the second conductor, which completes the circuit. This outer conductor is also enclosed in an insulating sheath, and the whole cable is protected by a plastic cover (see Figure 7.7).

**Figure 7.7** *Coaxial cable*

---

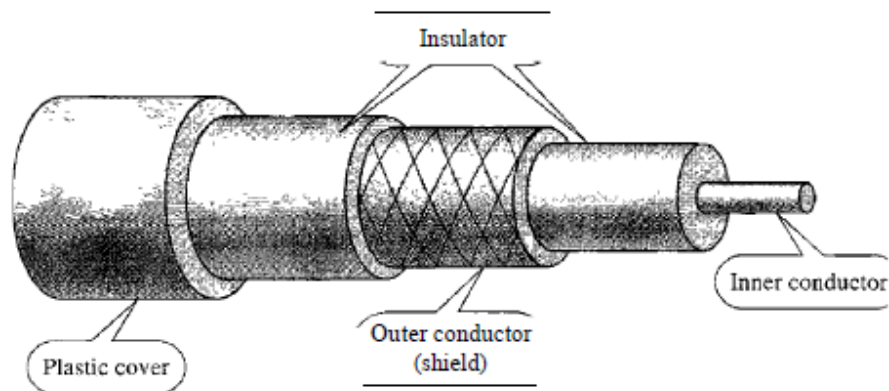

### ***Applications***

Coaxial cable was widely used in analog telephone networks where a single coaxial network could carry 10,000 voice signals. Later it was used in digital telephone networks where a single coaxial cable could carry digital data up to 600 Mbps. However, coaxial cable in telephone networks has largely been replaced today with fiber-optic cable. Cable TV networks also use coaxial cables. In the traditional cable TV network, the entire network used coaxial cable. Later, however, cable TV providers replaced most of the media with fiber-optic cable; hybrid networks use coaxial cable only at the network boundaries, near the consumer premises. Cable TV uses RG-59 coaxial cable. Another common application of coaxial cable is in traditional Ethernet LANs. Because of its high bandwidth, and consequently high data rate, coaxial cable was chosen for digital transmission in early Ethernet LANs.

3. **Fiber Optic Cable:** A fiber-optic cable is made of glass or plastic and transmits signals in the form of light. To understand optical fiber, we first need to explore several aspects of the nature of light. Light travels in a straight line as long as it is moving through a single uniform medium. If a ray of light traveling through one substance suddenly enters another substance (of a different density), the ray changes direction. Figure 7.10 shows how a ray of light changes direction when going from a more dense to a less dense substance.

Figure 7.10 *Bending of light ray*

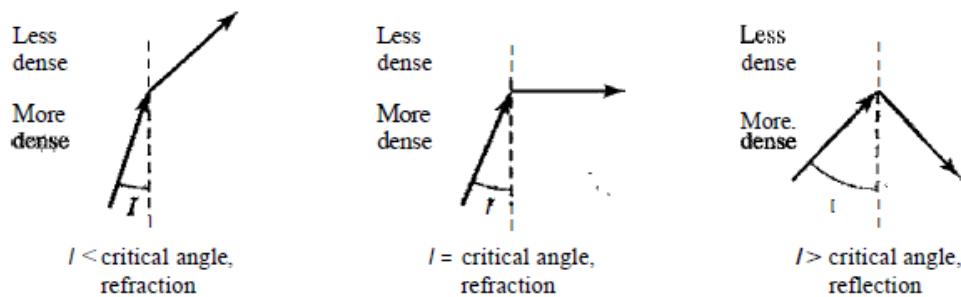

As the figure shows, if the angle of incidence  $I$  (the angle the ray makes with the line perpendicular to the interface between the two substances) is less than the critical angle, the ray refracts and moves closer to the surface. If the angle of incidence is equal to the critical angle, the light bends along the interface. If the angle is greater than the critical angle, the ray reflects (makes a turn) and travels again in the denser substance. Note that the critical angle is a property of the substance, and its value differs from one substance to another.

Optical fibers use reflection to guide light through a channel. A glass or plastic core is surrounded by a cladding of less dense glass or plastic. The difference in density of the two materials must be such that a beam of light moving through the core is reflected off the cladding instead of being refracted into it. See Figure 7.11.

Figure 7.11 *Optical fiber*

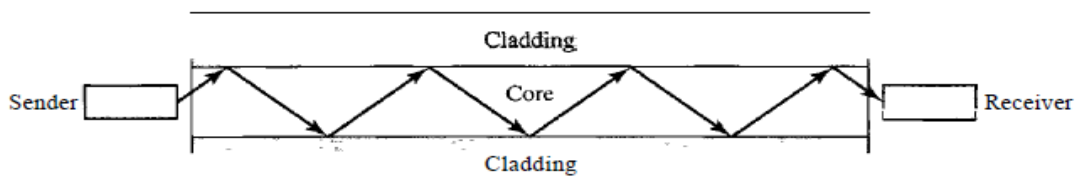



### ***Cable Composition***

Figure 7.14 shows the composition of a typical fiber-optic cable. The outer jacket is made of either PVC or Teflon. Inside the jacket are Kevlar strands to strengthen the cable. Kevlar is a strong material used in the fabrication of bulletproof vests. Below the Kevlar is another plastic coating to cushion the fiber. The fiber is at the center of the cable, and it consists of cladding and core.

---

**Figure 7.14** *Fiber construction*

---

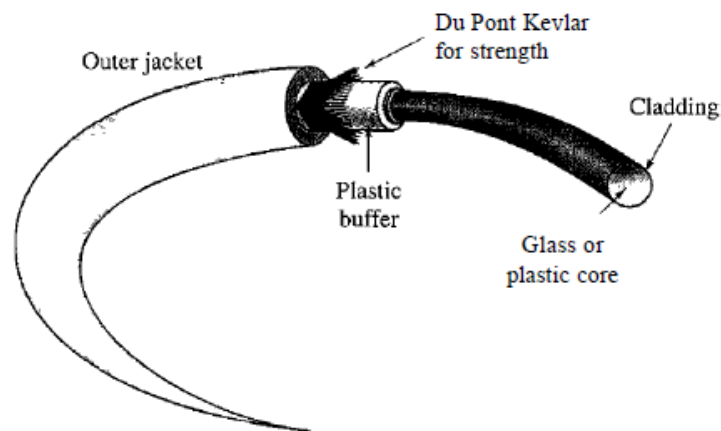

---

### ***Applications***

Fiber-optic cable is often found in backbone networks because its wide bandwidth is cost-effective. Today, with wavelength-division multiplexing (WDM), we can transfer data at a rate of 1600 Gbps. The SONET network provides such a backbone. Some cable TV companies use a combination of optical fiber and coaxial cable, thus creating a hybrid network. Optical fiber provides the backbone structure while coaxial cable provides the connection to the user premises. This is a cost-effective configuration since the narrow bandwidth requirement at the user end does not justify the use of optical fiber. Local-area networks such as 100Base-FX network (Fast Ethernet) and 1000Base-X also use fiber-optic cable.

### ***Advantages and Disadvantages of Optical Fiber***

#### **Advantages**

Fiber-optic cable has several advantages over metallic cable (twisted pair or coaxial).

a. **Higher bandwidth.** Fiber-optic cable can support dramatically higher bandwidths (and hence data rates) than either twisted-pair or coaxial cable. Currently, data rates and bandwidth

utilization over fiber-optic cable are limited not by the medium but by the signal generation and reception technology available.

b. **Less signal attenuation.** Fiber-optic transmission distance is significantly greater than that of other guided media. A signal can run for 50 km without requiring regeneration. We need repeaters every 5 km for coaxial or twisted-pair cable.

c. **Immunity to electromagnetic interference.** Electromagnetic noise cannot affect fiber-optic cables.

d. **Resistance to corrosive materials.** Glass is more resistant to corrosive materials than copper.

e. **Light weight.** Fiber-optic cables are much lighter than copper cables.

f. **Greater immunity to tapping.** Fiber-optic cables are more immune to tapping than copper cables. Copper cables create antenna effects that can easily be tapped.

### **Disadvantages**

There are some disadvantages in the use of optical fiber.

a. **Installation and maintenance.** Fiber-optic cable is a relatively new technology. Its installation and maintenance require expertise that is not yet available everywhere.

b. **Unidirectional light propagation.** Propagation of light is unidirectional. If we need bidirectional communication, two fibers are needed.

c. **Cost.** The cable and the interfaces are relatively more expensive than those of other guided media. If the demand for bandwidth is not high, often the use of optical fiber cannot be justified.

### **UNGUIDED MEDIA: WIRELESS**

Unguided media transport electromagnetic waves without using a physical conductor. This type of communication is often referred to as wireless communication. Signals are normally broadcast through free space and thus are available to anyone who has a device capable of receiving them.

Unguided signals can travel from the source to destination in several ways: ground propagation, sky propagation, and line-of-sight propagation, as shown in Figure 7.18. In ground propagation, radio waves travel through the lowest portion of the atmosphere, hugging the earth. These low-frequency signals emanate in all directions from the transmitting antenna and follow the curvature of the planet. Distance depends on the amount of power in the signal: The greater the power, the greater the distance. In sky propagation, higher-frequency radio waves radiate upward into the ionosphere where they are reflected back to earth. This type of transmission allows for greater distances with lower output power. In line-of-sight propagation, very high-frequency

signals are transmitted in straight lines directly from antenna to antenna. Antennas must be directional, facing each other, and either tall enough or close enough together not to be affected by the curvature of the earth. Line-of-sight propagation is tricky because radio transmissions cannot be completely focused.

---

**Figure 7.18** *Propagation methods*

---

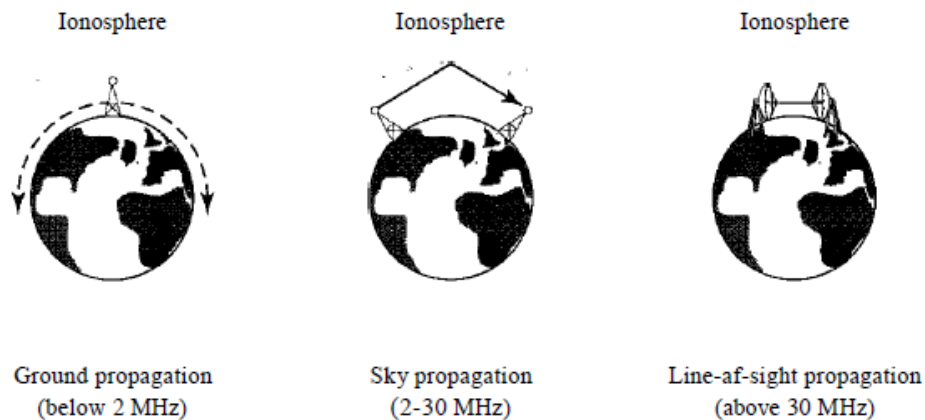

---

## **1. Radio Waves**

Waves ranging in frequencies between 3 kHz and 1 GHz are called radio waves. Radio waves, for the most part, are omnidirectional. When an antenna transmits radio waves, they are propagated in all directions. This means that the sending and receiving antennas do not have to be aligned. A sending antenna sends waves that can be received by any receiving antenna. The omnidirectional property has a disadvantage, too. The radio waves transmitted by one antenna are susceptible to interference by another antenna that may send signals using the same frequency or band. Radio waves, particularly those waves that propagate in the sky mode, can travel long distances. This makes radio waves a good candidate for long-distance broadcasting such as AM radio. Radio waves, particularly those of low and medium frequencies, can penetrate walls. This characteristic can be both an advantage and a disadvantage. It is an advantage because, for example, an AM radio can receive signals inside a building. It is a disadvantage because we cannot isolate a communication to just inside or outside a building. The radio wave band is relatively narrow, just under 1 GHz, compared to the microwave band. When this band is divided into sub bands, the sub bands are also narrow, leading to a low data rate for digital communications.

### ***Omnidirectional Antenna***

Radio waves use omnidirectional antennas that send out signals in all directions. Based on the wavelength, strength, and the purpose of transmission, we can have several types of antennas. Figure 7.20 shows an omnidirectional antenna.

#### ***Applications***

The omnidirectional characteristics of radio waves make them useful for multicasting, in which there is one sender but many receivers. AM and FM radio, television, maritime radio, cordless phones, and paging are examples of multicasting.

---

**Figure 7.20** *Omnidirectional antenna*

---

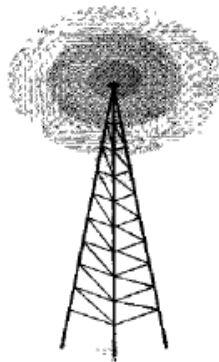

---

## **2. Microwaves**

Electromagnetic waves having frequencies between 1 and 300 GHz are called microwaves. Microwaves are unidirectional. When an antenna transmits microwave waves, they can be narrowly focused. This means that the sending and receiving antennas need to be aligned. The unidirectional property has an obvious advantage. A pair of antennas can be aligned without interfering with another pair of aligned antennas. The following describes some characteristics of microwave propagation:

- a. Microwave propagation is line-of-sight. Since the towers with the mounted antennas need to be in direct sight of each other, towers that are far apart need to be very tall. The curvature of the earth as well as other blocking obstacles do not allow two short towers to communicate by using microwaves. Repeaters are often needed for long distance communication.
- b. Very high-frequency microwaves cannot penetrate walls. This characteristic can be a disadvantage if receivers are inside buildings.

- c. The microwave band is relatively wide, almost 299 GHz. Therefore wider sub bands can be assigned, and a high data rate is possible
- d. Use of certain portions of the band requires permission from authorities.

### ***Unidirectional Antenna***

Microwaves need unidirectional antennas that send out signals in one direction. Two types of antennas are used for microwave communications: the parabolic dish and the horn (see Figure 7.21). A parabolic dish antenna is based on the geometry of a parabola: Every line parallel to the line of symmetry (line of sight) reflects off the curve at angles such that all the lines intersect in a common point called the focus. The parabolic dish works as a funnel, catching a wide range of waves and directing them to a common point. In this way, more of the signal is recovered than would be possible with a single-point receiver. Outgoing transmissions are broadcast through a horn aimed at the dish. The microwaves hit the dish and are deflected outward in a reversal of the receipt path. A horn antenna looks like a gigantic scoop. Outgoing transmissions are broadcast up a stem (resembling a handle) and deflected outward in a series of narrow parallel beams by the curved head. Received transmissions are collected by the scooped shape of the horn, in a manner similar to the parabolic dish, and are deflected down into the stem.

---

**Figure 7.21** *Unidirectional antennas*

---

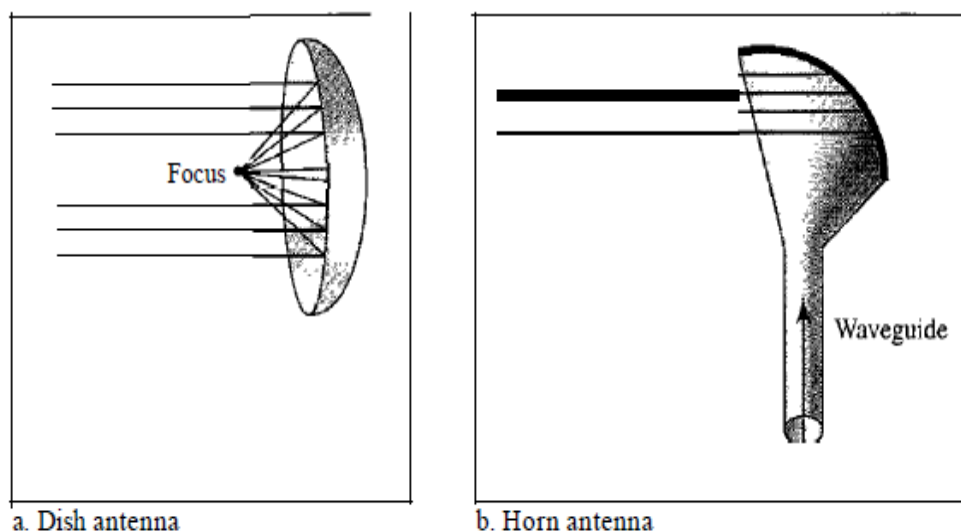

### **3. Infrared**

Infrared waves, with frequencies from 300 GHz to 400 THz (wavelengths from 1 mm to 770 nm), can be used for short-range communication. Infrared waves, having high frequencies, cannot penetrate walls. This advantageous characteristic prevents interference between one system and another; a short-range communication system in one room cannot be affected by another system in the next room. When we use our infrared remote control, we do not interfere with the use of the remote by our neighbors. However, this same characteristic makes infrared signals useless for long-range communication. In addition, we cannot use infrared waves outside a building because the sun's rays contain infrared waves that can interfere with the communication.

#### ***Applications***

The infrared band, almost 400 THz, has an excellent potential for data transmission. Such a wide bandwidth can be used to transmit digital data with a very high data rate. The *Infrared Data Association* (IrDA), an association for sponsoring the use of infrared waves, has established standards for using these signals for communication between devices such as keyboards, mice, PCs, and printers. For example, some manufacturers provide a special port called the IrDA port that allows a wireless keyboard to communicate with a PC. The standard originally defined a data rate of 75 kbps for a distance up to 8 m. The recent standard defines a data rate of 4 Mbps. Infrared signals defined by IrDA transmit through line of sight; the IrDA port on the keyboard needs to point to the PC for transmission to occur.

## **SWITCHING**

A network is a set of connected devices. Whenever we have multiple devices, we have the problem of how to connect them to make one-to-one communication possible. One solution is to make a point-to-point connection between each pair of devices (a mesh topology) or between a central device and every other device (a star topology). These methods, however, are impractical and wasteful when applied to very large networks. The number and length of the links require too much infrastructure to be cost-efficient, and the majority of those links would be idle most of the time. Other topologies employing multipoint connections, such as a bus, are ruled out because the distances between devices and the total number of devices increase beyond the capacities of the media and equipment.

A better solution is **switching**. A switched network consists of a series of interlinked nodes, called switches. Switches are devices capable of creating temporary connections between two or more devices linked to the switch. In a switched network, some of these nodes are connected to the end systems (computers or telephones, for example). Others are used only for routing. Figure 8.1 shows a switched network.

Figure 8.1 *Switched network*

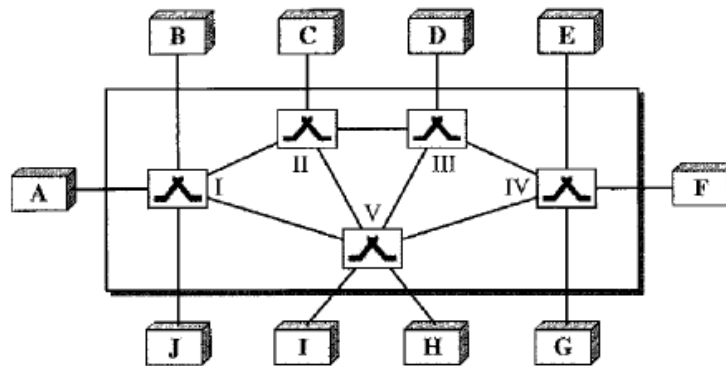

The end systems (communicating devices) are labeled A, B, C, D, and so on, and the switches are labeled I, II, III, IV, and V. Each switch is connected to multiple links. Traditionally, three methods of switching have been important: circuit switching, packet switching, and message switching. The first two are commonly used today. The third has been phased out in general communications but still has networking applications. We can then divide today's networks into three broad categories: circuit-switched networks, packet-switched networks, and message-switched.

Figure 8.2 *Taxonomy of switched networks*

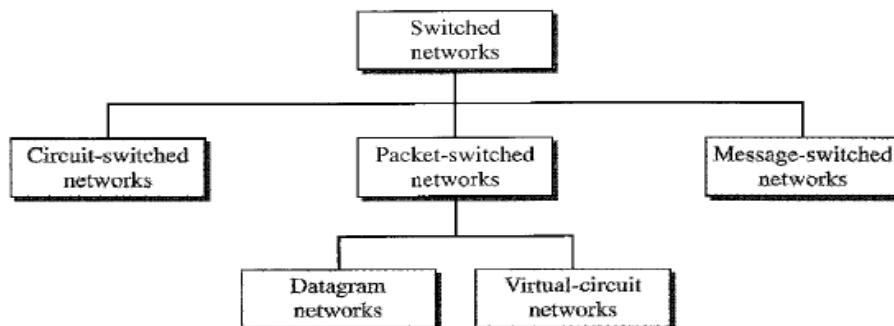

## 1. CIRCUIT-SWITCHED NETWORKS

A circuit-switched network consists of a set of switches connected by physical links. A connection between two stations is a dedicated path made of one or more links. However, each connection uses only one dedicated channel on each link. Each link is normally divided into  $n$  channels by using FDM or TDM. Figure 8.3 shows a trivial circuit-switched network with four switches and four links. Each link is divided into  $n$  ( $n$  is 3 in the figure) channels by using FDM or TDM.

---

Figure 8.3 *A trivial circuit-switched network*

---

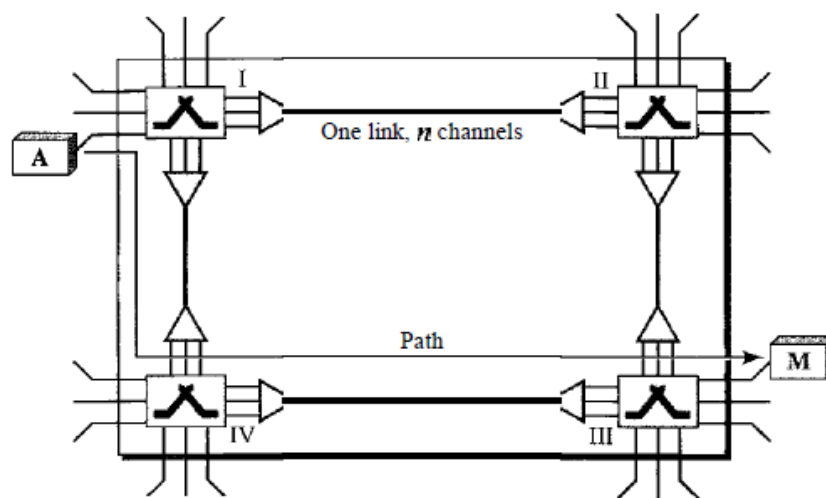

---

The end systems, such as computers or telephones, are directly connected to a switch. We have shown only two end systems for simplicity. When end system A needs to communicate with end system M, system A needs to request a connection to M that must be accepted by all switches as well as by M itself. This is called the setup phase; a circuit (channel) is reserved on each link, and the combination of circuits or channels defines the dedicated path. After the dedicated path made of connected circuits (channels) is established, data transfer can take place. After all data have been transferred, the circuits are torn down.

### Three Phases

The actual communication in a circuit-switched network requires three phases: connection setup, data transfer, and connection teardown.



### *Setup Phase*

Before the two parties (or multiple parties in a conference call) can communicate, a dedicated circuit (combination of channels in links) needs to be established. The end systems are normally connected through dedicated lines to the switches, so connection setup means creating dedicated channels between the switches. For example, in Figure 8.3, when system A needs to connect to system M, it sends a setup request that includes the address of system M, to switch I. Switch I finds a channel between itself and switch IV that can be dedicated for this purpose. Switch I then sends the request to switch IV, which finds a dedicated channel between itself and switch III. Switch III informs system M of system A's intention at this time. In the next step to making a connection, an acknowledgment from system M needs to be sent in the opposite direction to system A. Only after system A receives this acknowledgment is the connection established.

### *Data Transfer Phase*

After the establishment of the dedicated circuit (channels), the two parties can transfer data.

### *Teardown Phase*

When one of the parties needs to disconnect, a signal is sent to each switch to release the resources.

## **2. PACKET SWITCHED NETWORK**

In a Computer Network, the communication between two ends is done in blocks of data called packets. So instead of continuous communication the exchange takes place in the form of individual packets between the two computers. This allows us to make the switches function for both storing and forwarding because a packet is an independent entity that can be stored and sent later.

### **a. DATAGRAM NETWORKS**

In data communications, we need to send messages from one end system to another. If the message is going to pass through a packet-switched network, it needs to be divided into packets of fixed or variable size. The size of the packet is determined by the network and the governing protocol. In packet switching, there is no resource allocation for a packet. This means that there is no reserved bandwidth on the links, and there is no scheduled processing time for each packet. Resources are allocated on demand. The allocation is done on a first come, first-served basis. When a switch receives a packet, no matter what is the source or destination, the packet must wait if there are other packets being processed. As with other systems in our daily life, this lack

of reservation may create delay. For example, if we do not have a reservation at a restaurant, we might have to wait. In a datagram network, each packet is treated independently of all others. Even if a packet is part of a multipacket transmission, the network treats it as though it existed alone. Packets in this approach are referred to as datagrams. Datagram switching is normally done at the network layer. The switches in a datagram network are traditionally referred to as routers.

**Figure 8.7** *A datagram network with four switches (routers)*

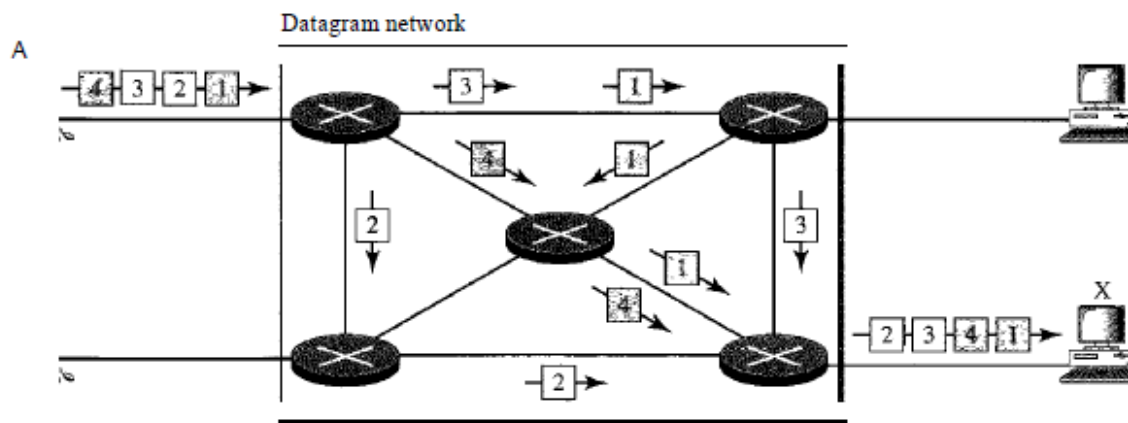

In this example, all four packets (or datagrams) belong to the same message, but may travel different paths to reach their destination. This is so because the links may be involved in carrying packets from other sources and do not have the necessary bandwidth available to carry all the packets from A to X. This approach can cause the datagrams of a transmission to arrive at their destination out of order with different delays between them packets. Packets may also be lost or dropped because of a lack of resources. In most protocols, it is the responsibility of an upper-layer protocol to reorder the datagrams or ask for lost datagrams before passing them on to the application. The datagram networks are sometimes referred to as connectionless networks. The term *connectionless* here means that the switch (packet switch) does not keep information about the connection state. There are no setup or teardown phases. Each packet is treated the same by a switch regardless of its source or destination.

### b. **VIRTUAL-CIRCUIT NETWORKS**

A virtual-circuit network is a cross between a circuit-switched network and a datagram network. It has some characteristics of both.

1. As in a circuit-switched network, there are setup and teardown phases in addition to the data transfer phase.
2. Resources can be allocated during the setup phase, as in a circuit-switched network, or on demand, as in a datagram network.
3. As in a datagram network, data are packetized and each packet carries an address in the header. However, the address in the header has local jurisdiction, not end-to-end jurisdiction. The reader may ask how the intermediate switches know where to send the packet if there is no final destination address carried by a packet.
4. As in a circuit-switched network, all packets follow the same path established during the connection.
5. A virtual-circuit network is normally implemented in the data link layer, while a circuit-switched network is implemented in the physical layer and a datagram network in the network layer. But this may change in the future.

Figure 8.10 is an example of a virtual-circuit network. The network has switches that allow traffic from sources to destinations. A source or destination can be a computer, packet switch, bridge, or any other device that connects other networks.

**Figure 8.10** *Virtual-circuit network*

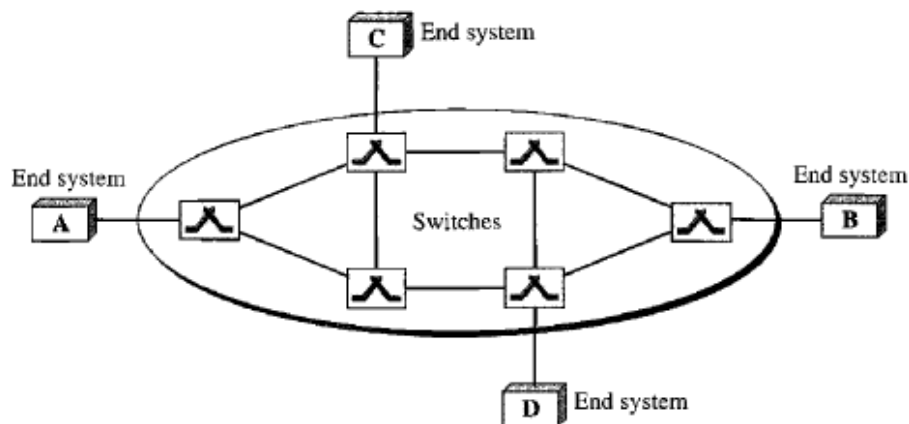

## DATA TRANSMISSION AND MODES

The transmission of binary data across a link can be accomplished in either parallel or serial mode. In parallel mode, multiple bits are sent with each clock tick. In serial mode, 1 bit is sent with each clock tick. While there is only one way to send parallel data, there are three subclasses of serial transmission: asynchronous, synchronous, and isochronous.

Figure 4.31 *Data transmission and modes*

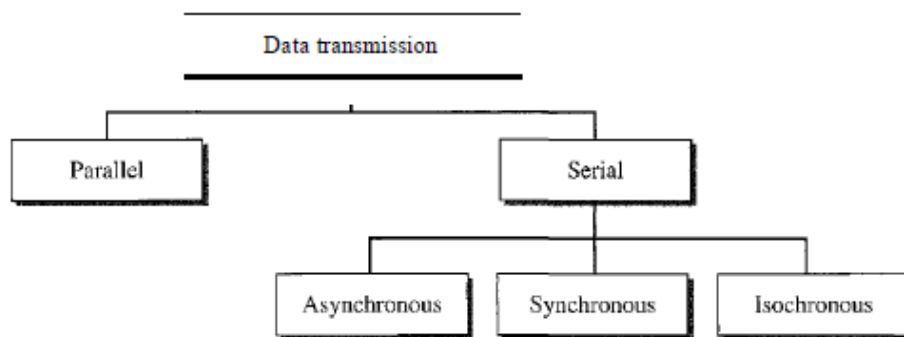

### 1. Parallel Transmission

Binary data, consisting of 1s and 0s, may be organized into groups of  $n$  bits each. Computers produce and consume data in groups of bits much as we conceive of and use spoken language in the form of words rather than letters. By grouping, we can send data  $n$  bits at a time instead of 1. This is called parallel transmission. The mechanism for parallel transmission is a conceptually simple one: Use  $n$  wires to send  $n$  bits at one time. That way each bit has its own wire, and all  $n$  bits of one group can be transmitted with each clock tick from one device to another. Figure 4.32 shows how parallel transmission works for  $n = 8$ . Typically, the eight wires are bundled in a cable with a connector at each end. The advantage of parallel transmission is speed. All else being equal, parallel transmission can increase the transfer speed by a factor of  $n$  over serial transmission.

But there is a significant disadvantage: cost. Parallel transmission requires  $n$  communication lines just to transmit the data stream. Because this is expensive, parallel transmission is usually limited to short distances.

---

Figure 4.32 *Parallel transmission*

---

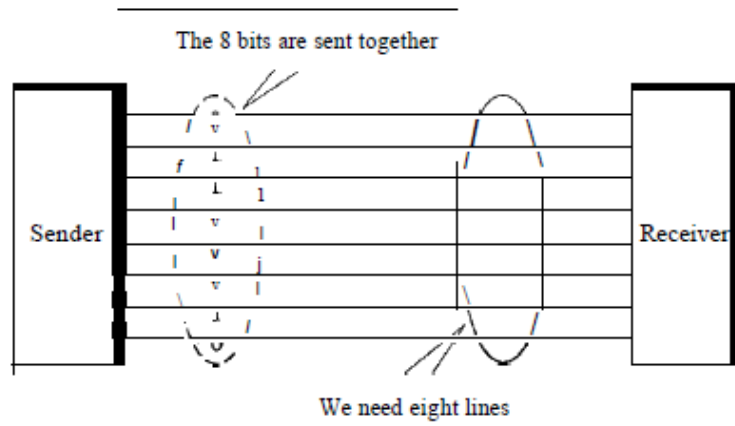

---

## 2. Serial Transmission

In serial transmission one bit follows another, so we need only one communication channel rather than  $n$  to transmit data between two communicating devices (see Figure 4.33).

---

Figure 4.33 *Serial transmission*

---

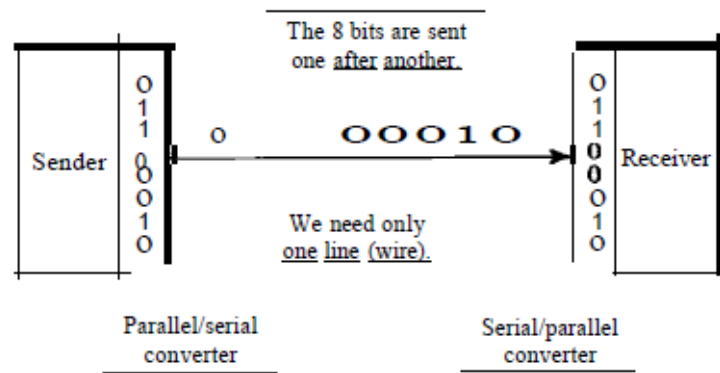

---

The advantage of serial over parallel transmission is that with only one communication channel, serial transmission reduces the cost of transmission over parallel by roughly a factor of  $n$ . Since communication within devices is parallel, conversion devices are required at the interface between the sender and the line (parallel-to-serial) and between the line and the receiver (serial-to-parallel).

Serial transmission occurs in one of three ways: asynchronous, synchronous, and isochronous.

a. **Asynchronous Transmission**

Asynchronous transmission is so named because the timing of a signal is unimportant. Instead, information is received and translated by agreed upon patterns. As long as those patterns are followed, the receiving device can retrieve the information without regard to the rhythm in which it is sent. Patterns are based on grouping the bit stream into bytes. Each group, usually 8 bits, is sent along the link as a unit. The sending system handles each group independently, relaying it to the link whenever ready, without regard to a timer. Without synchronization, the receiver cannot use timing to predict when the next group will arrive. To alert the receiver to the arrival of a new group, therefore, an extra bit is added to the beginning of each byte. This bit, usually a 0, is called the start bit. To let the receiver know that the byte is finished, 1 or more additional bits are appended to the end of the byte. These bits, usually 1s, are called stop bits. By this method, each byte is increased in size to at least 10 bits, of which 8 bits is information and 2 bits or more are signals to the receiver. In addition, the transmission of each byte may then be followed by a gap of varying duration. This gap can be represented either by an idle channel or by a stream of additional stop bits. The start and stop bits and the gap alert the receiver to the beginning and end of each byte and allow it to synchronize with the data stream. This mechanism is called *asynchronous* because, at the byte level, the sender and receiver do not have to be synchronized. But within each byte, the receiver must still be synchronized with the incoming bit stream. That is, some synchronization is required, but only for the duration of a single byte. The receiving device resynchronizes at the onset of each new byte. When the receiver detects a start bit, it sets a timer and begins counting bits as they come in. After  $n$  bits, the receiver looks for a stop bit. As soon as it detects the stop bit, it waits until it detects the next start bit. Figure 4.34 is a schematic illustration of asynchronous transmission. In this example, the start bits are 0s, the stop bits are 1s, and the gap is represented by an idle line rather than by additional stop bits.

The addition of stop and start bits and the insertion of gaps into the bit stream make asynchronous transmission slower than forms of transmission that can operate without the addition of control information. But it is cheap and effective, two advantages that make it an attractive choice for situations such as low-speed communication. For example, the connection of a keyboard to a computer is a natural application for asynchronous transmission. A user types slowly in data processing terms, and leaves unpredictable gaps of time between each character.

---

Figure 4.34 *Asynchronous transmission*

---

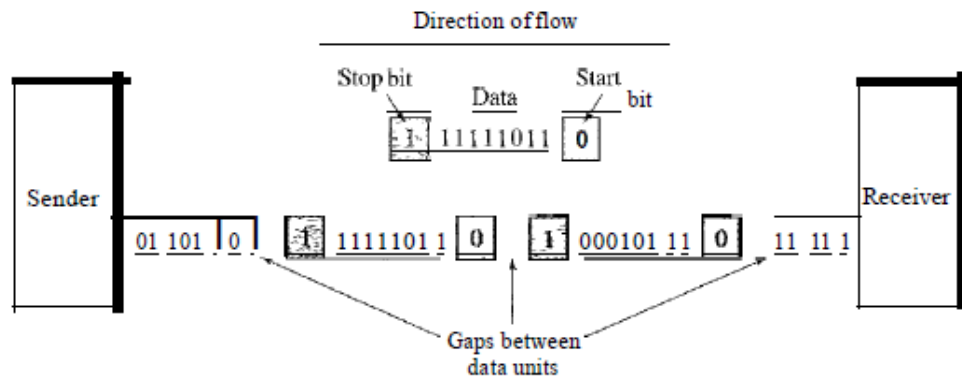

---

**b. Synchronous Transmission**

In synchronous transmission, the bit stream is combined into longer "frames," which may contain multiple bytes. Each byte, however, is introduced onto the transmission link without a gap between it and the next one. It is left to the receiver to separate the bit stream into bytes for decoding purposes. In other words, data are transmitted as an unbroken string of 1s and 0s, and the receiver separates that string into the bytes, or characters, it needs to reconstruct the information. Figure 4.35 gives a schematic illustration of synchronous transmission. We have drawn in the divisions between bytes. In reality, those divisions do not exist; the sender puts its data onto the line as one long string. If the sender wishes to send data in separate bursts, the gaps between bursts must be filled with a special sequence of 0s and 1s that means *idle*. The receiver counts the bits as they arrive and groups them in 8-bit units. Without gaps and start and stop bits, there is no built-in mechanism to help the receiving device adjust its bit synchronization midstream. Timing becomes very important, therefore, because the accuracy of the received information is completely dependent on the ability of the receiving device to keep an accurate count of the bits as they come in. The advantage of synchronous transmission is speed. With no extra bits or gaps to introduce at the sending end and remove at the receiving end, and, by extension, with fewer bits to move across the link, synchronous transmission is faster than asynchronous transmission. For this reason, it is more useful for high-speed applications such as the transmission of data from one computer to another. Byte synchronization is accomplished in the data link layer.

Figure 4.35 Synchronous transmission

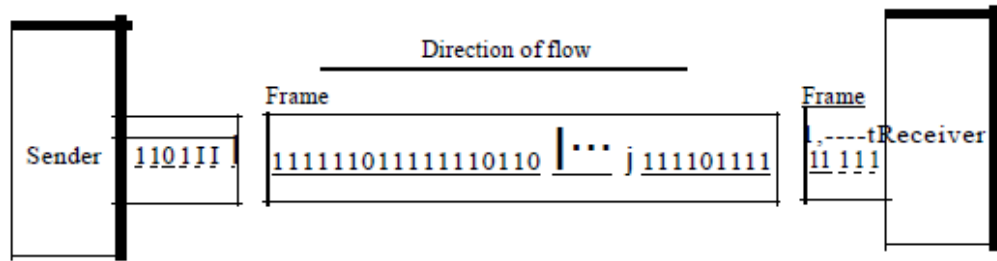

**c. Isochronous**

In real-time audio and video, in which uneven delays between frames are not acceptable, synchronous transmission fails. For example, TV images are broadcast at the rate of 30 images per second; they must be viewed at the same rate. If each image is sent by using one or more frames, there should be no delays between frames. For this type of application, synchronization between characters is not enough; the entire stream of bits must be synchronized. The isochronous transmission guarantees that the data arrive at a fixed rate.

**CYCLIC REDUNDANCY CHECK (CRC)**

Cyclic codes are special linear block codes with one extra property. In a cyclic code, if a codeword is cyclically shifted (rotated), the result is another codeword. For example, if 1011000 is a codeword and we cyclically left-shift, then 0110001 is also a codeword. In this case, if we call the bits in the first word  $a_0$  to  $a_6$  and the bits in the second word  $b_0$  to  $b_6$ .

Figure 10.14 CRC encoder and decoder

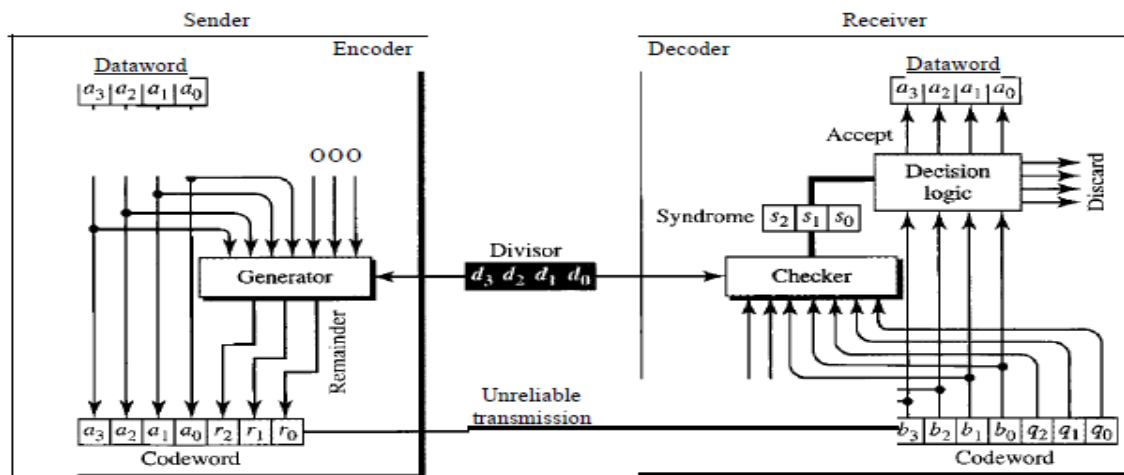



In the encoder, the dataword has  $k$  bits (4 here); the codeword has  $n$  bits (7 here). The size of the dataword is augmented by adding  $n - k$  (3 here) 0s to the right-hand side of the word. The  $n$ -bit result is fed into the generator. The generator uses a divisor of size  $n - k + 1$  (4 here), predefined and agreed upon. The generator divides the augmented dataword by the divisor (modulo-2 division). The quotient of the division is discarded; the remainder ( $r_2r_1r_0$ ) is appended to the dataword to create the codeword. The decoder receives the possibly corrupted codeword. A copy of all  $n$  bits is fed to the checker which is a replica of the generator. The remainder produced by the checker is a syndrome of  $n - k$  (3 here) bits, which is fed to the decision logic analyzer. The analyzer has a simple function. If the syndrome bits are all as, the 4 leftmost bits of the codeword are accepted as the dataword (interpreted as no error); otherwise, the 4 bits are discarded (error).

### Encoder

Let us take a closer look at the encoder. The encoder takes the dataword and augments it with  $n - k$  number of 0's. It then divides the augmented dataword by the divisor, as shown in Figure 10.15.

Figure 10.15 Division in CRC encoder

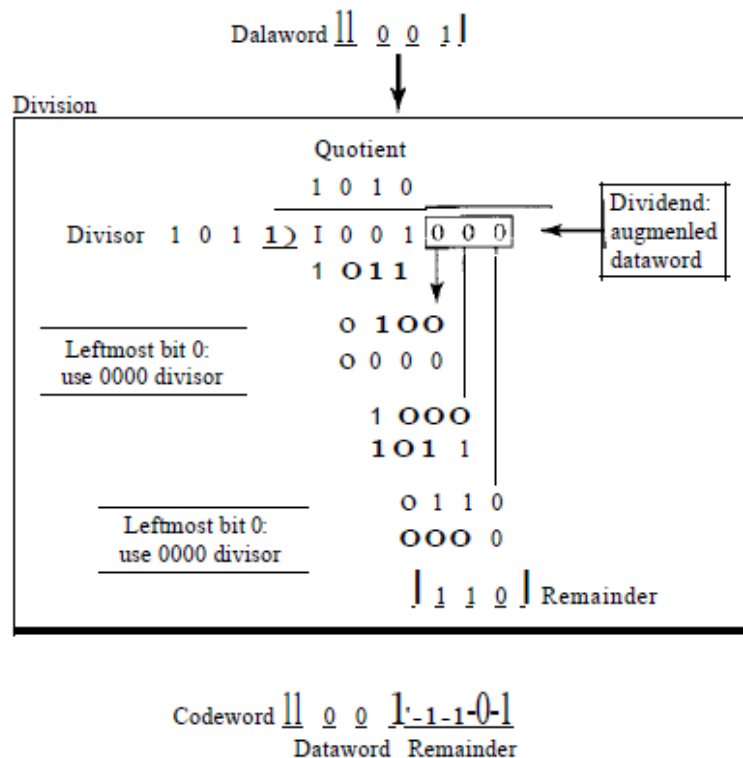

As in decimal division, the process is done step by step. In each step, a copy of the divisor is XORed with the 4 bits of the dividend. The result of the XOR operation (remainder) is 3 bits (in this case), which is used for the next step after 1 extra bit is pulled down to make it 4 bits long. There is one important point we need to remember in this type of division. If the leftmost bit of the dividend (or the part used in each step) is 0, the step cannot use the regular divisor; we need to use an all-0s divisor. When there are no bits left to pull down, we have a result. The 3-bit remainder forms the check bits ( $r_2$ ,  $r_1$  and  $r_0$ ). They are appended to the dataword to create the codeword.

**Decoder**

The codeword can change during transmission. The decoder does the same division process as the encoder. The remainder of the division is the syndrome. If the syndrome is all 0s, there is no error; the dataword is separated from the received codeword and accepted. Otherwise, everything is discarded. Figure 10.16 shows two cases: The left hand figure shows the value of syndrome when no error has occurred; the syndrome is 000. The right-hand part of the figure shows the case in which there is one single error. The syndrome is not all 0s .

**Figure 10.7** Division in the CRC decoder for two cases

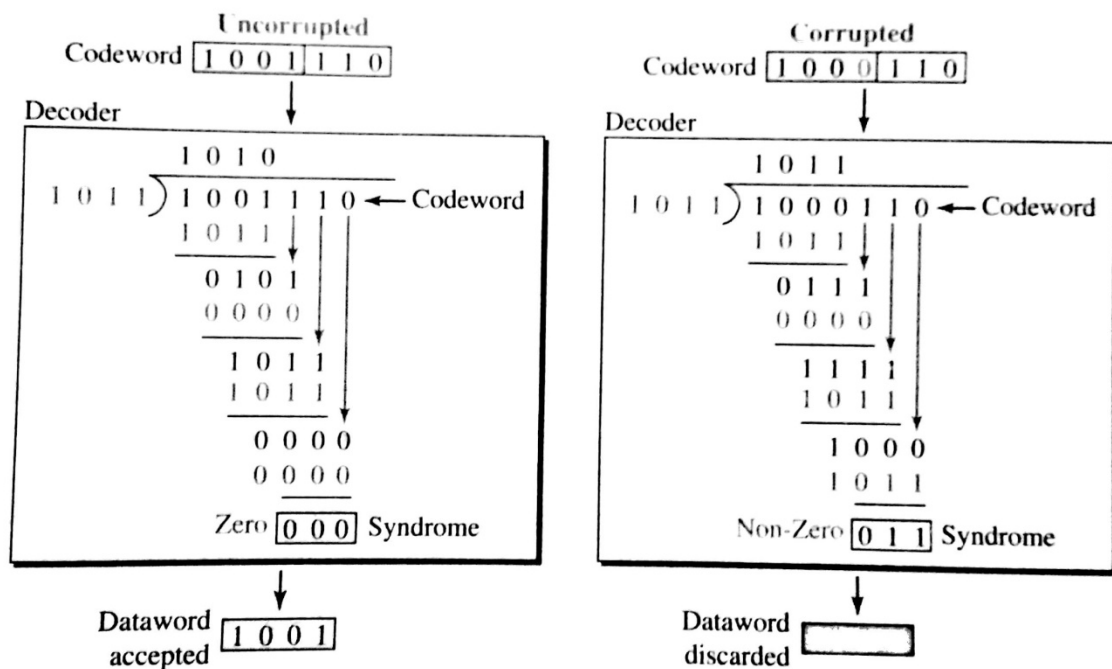

### Divisor

Let us first consider the divisor. We need to note the following points:

1. The divisor is repeatedly XORed with part of the dividend.
2. The divisor has  $n - k + 1$  bits which either are predefined or are all Os. In other words, the bits do not change from one dataword to another. In our previous example, the divisor bits were either 1011 or 0000. The choice was based on the leftmost bit of the part of the augmented data bits that are active in the XOR operation.
3. A close look shows that only  $n - k$  bits of the divisor is needed in the XOR operation. The leftmost bit is not needed because the result of the operation is always 0, no matter what the value of this bit. The reason is that the inputs to this XOR operation are either both Os or both 1s. In our previous example, only 3 bits, not 4, is actually used in the XOR operation.

### Polynomials

A better way to understand cyclic codes and how they can be analyzed is to represent them as polynomials.

A pattern of Os and 1s can be represented as a **polynomial** with coefficients of 0 and 1. The power of each term shows the position of the bit; the coefficient shows the value of the bit. Figure 10.21 shows a binary pattern and its polynomial representation. In Figure 10.21a we show how to translate a binary pattern to a polynomial; in Figure 10.21b we show how the polynomial can be shortened by removing all terms with zero coefficients.

**Figure 10.21** A polynomial to represent a binary word

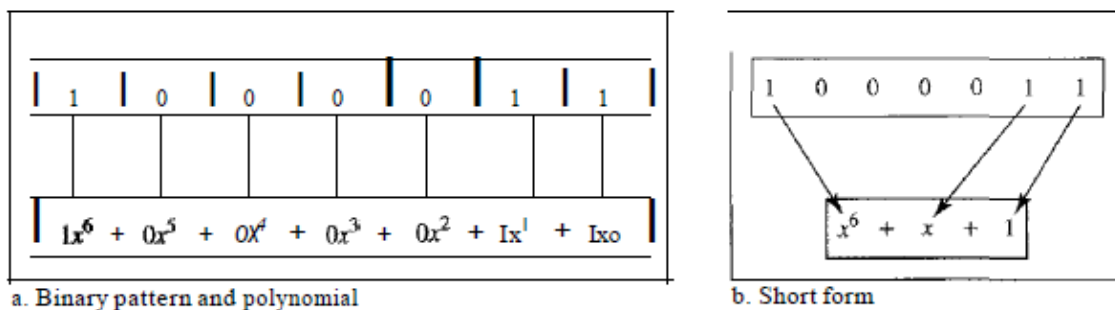

Figure 10.21 shows one immediate benefit; a 7-bit pattern can be replaced by three terms. The benefit is even more conspicuous when we have a polynomial such as  $x^{23} + x^3 + 1$ . Here the bit pattern is 24 bits in length (three 1s and twenty-one 0s) while the polynomial is just three terms.

## PARITY CHECK CODE

The most familiar error-detecting code is the simple parity-check code. In this code, a  $k$ -bit dataword is changed to an  $n$ -bit codeword where  $n = k + 1$ . The extra bit, called the parity bit, is selected to make the total number of 1s in the codeword even. Although some implementations specify an odd number of 1's. The minimum Hamming distance for this category is  $d_{min} = 2$ , which means that the code is a single-bit error-detecting code; it cannot correct any error.

Our first code (Table 10.1) is a parity-check code with  $k = 4$  and  $n = 5$ .

**Table 10.3** Simple parity-check code  $C(5, 4)$

<i>Datawords</i>	<i>Codewords</i>	<i>Datawords</i>	<i>Codewords</i>
0000	00000	1000	10001
0001	00011	1001	10010
0010	00101	1010	10100
0011	00110	1011	10111
0100	01001	1100	11000
0101	01010	1101	11011
0110	01100	1110	11101
0111	01111	1111	11110

Figure 10.10 shows a possible structure of an encoder (at the sender) and a decoder (at the receiver). The encoder uses a generator that takes a copy of a 4-bit dataword ( $a_0, a_1, a_2, a_3$ ) and generates a parity bit  $p_0$ . The dataword bits and the parity bit create the 5-bit codeword. The parity bit that is added makes the number of 1s in the codeword even.

**Figure 10.10** Encoder and decoder for simple parity-check code

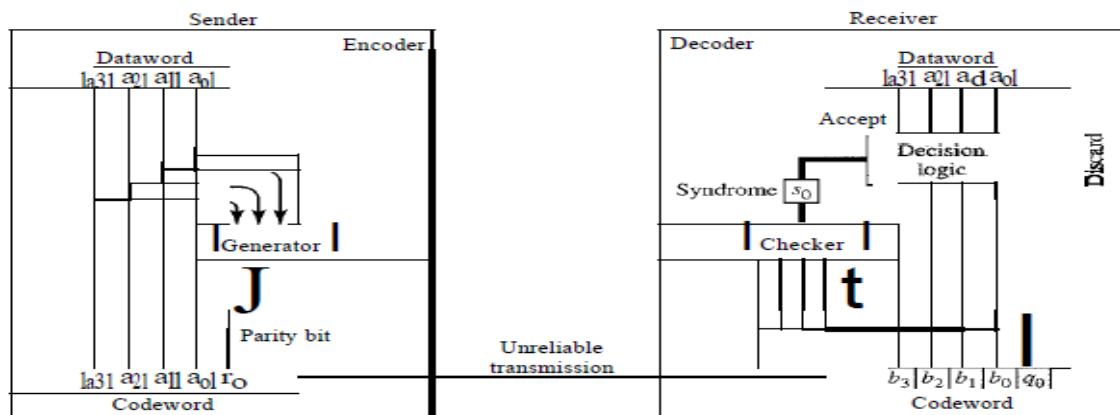

This is normally done by adding the 4 bits of the dataword (modulo-2); the result is the parity bit. In other words,

$$r_0 = a_3 + a_2 + a_1 + a_0 \quad (\text{modulo-2})$$

If the number of 1s is even, the result is 0; if the number of 1s is odd, the result is 1. In both cases, the total number of 1s in the codeword is even. The sender sends the codeword which may be corrupted during transmission. The receiver receives a 5-bit word. The checker at the receiver does the same thing as the generator in the sender with one exception: The addition is done over all 5 bits. The result, which is called the syndrome, is just 1 bit. The syndrome is 0 when the number of 1s in the received codeword is even; otherwise, it is 1.

$$s_0 = b_3 + b_2 + b_1 + b_0 + q_0 \quad (\text{modulo-2})$$

The syndrome is passed to the decision logic analyzer. If the syndrome is 0, there is no error in the received codeword; the data portion of the received codeword is accepted as the dataword; if the syndrome is 1, the data portion of the received codeword is discarded. The dataword is not created.

## **HDLC**

High-level Data Link Control (HDLC) is a bit-oriented protocol for communication over point-to-point and multipoint links.

### *Configurations and Transfer Modes*

HDLC provides two common transfer modes that can be used in different configurations: normal response mode (NRM) and asynchronous balanced mode (ABM).

#### *Normal Response Mode*

In normal response mode (NRM), the station configuration is unbalanced. We have one primary station and multiple secondary stations. A primary station can send commands; a secondary station can only respond. The NRM is used for both point-to-point and multiple-point links, as shown in Figure 11.25.

#### *Asynchronous Balanced Mode*

In asynchronous balanced mode (ABM), the configuration is balanced. The link is point-to-point, and each station can function as a primary and a secondary (acting as peers), as shown in Figure 11.26. This is the common mode today.

---

Figure 11.25 *Normal response mode*

---

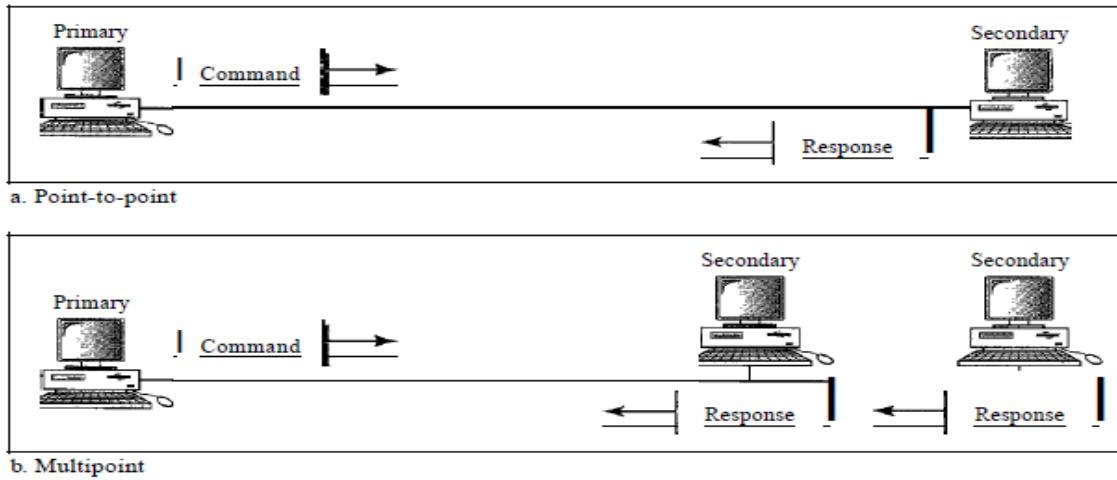

---

Figure 11.26 *Asynchronous balanced mode*

---

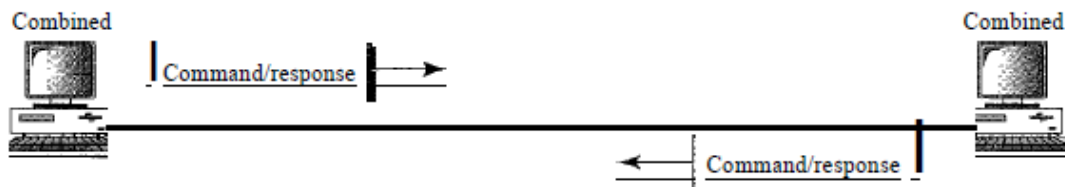

### **Frames**

To provide the flexibility necessary to support all the options possible in the modes and configurations just described, HDLC defines three types of frames: information frames (I-frames), supervisory frames (S-frames), and unnumbered frames (V-frames). Each type of frame serves as an envelope for the transmission of a different type of message. I-frames are used to transport user data and control information relating to user data (piggybacking). S-frames are used only to transport control information. V-frames are reserved for system management. Information carried by V-frames is intended for managing the link itself.

#### *Frame Format*

Each frame in HDLC may contain up to six fields, as shown in Figure 11.27: a beginning flag field, an address field, a control field, an information field, a frame check sequence (FCS) field,

and an ending flag field. In multiple-frame transmissions, the ending flag of one frame can serve as the beginning flag of the next frame.

---

Figure 11.27 HDLC frames

---

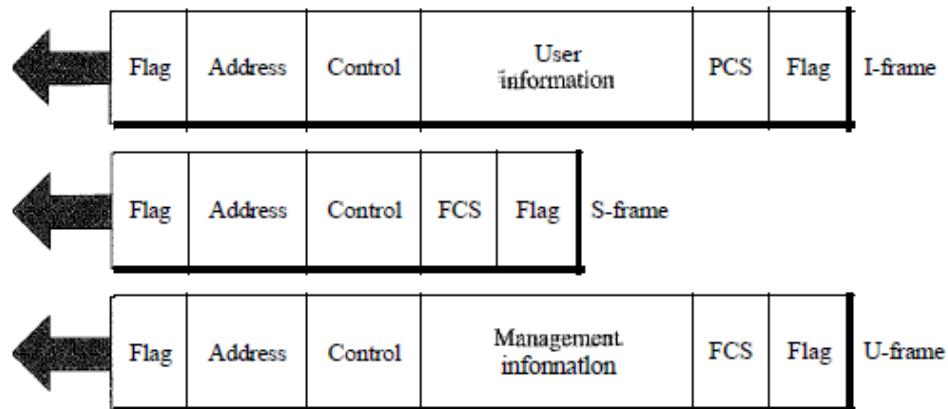

---

### Fields

Let us now discuss the fields and their use in different frame types.

- o **Flag field.** The flag field of an HDLC frame is an 8-bit sequence with the bit pattern 01111110 that identifies both the beginning and the end of a frame and serves as a synchronization pattern for the receiver.
- o **Address field.** The second field of an HDLC frame contains the address of the secondary station. If a primary station created the frame, it contains a *to* address. If a secondary creates the frame, it contains a *from* address. An address field can be 1 byte or several bytes long, depending on the needs of the network. One byte can identify up to 128 stations (1 bit is used for another purpose). Larger networks require multiple-byte address fields. If the address field is only 1 byte, the last bit is always a 1. If the address is more than 1 byte, all bytes but the last one will end with 0; only the last will end with 1. Ending each intermediate byte with 0 indicates to the receiver that there are more address bytes to come.
- o **Control field.** The control field is a 1- or 2-byte segment of the frame used for flow and error control. The interpretation of bits in this field depends on the frame type.
- o **Information field.** The information field contains the user's data from the network layer or management information. Its length can vary from one network to another.
- o **FCS field.** The frame check sequence (FCS) is the HDLC error detection field.

## Control Field

The control field determines the type of frame and defines its functionality. The format is specific for the type of frame, as shown in Figure 11.28.

---

Figure 11.28 Control field format for the different frame types

---

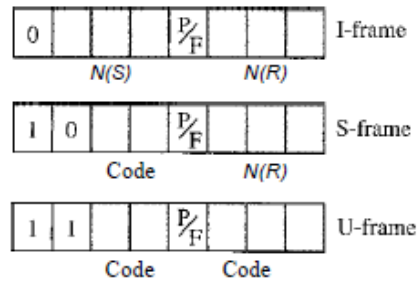

---

### Control Field for I-Frames

I-frames are designed to carry user data from the network layer. In addition, they can include flow and error control information (piggybacking). The subfields in the control field are used to the control field is 0, this means the frame is an I-frame. The next 3 bits, called  $N(S)$ , define the sequence number of the frame. Note that with 3 bits, we can define a sequence number between 0 and 7; but in the extension format, in which the control field is 2 bytes, this field is larger. The last 3 bits, called  $N(R)$ , correspond to the acknowledgment number when piggybacking is used. The single bit between  $N(S)$  and  $N(R)$  is called the  $PIF$  bit. The  $PIF$  field is a single bit with a dual purpose. It has meaning only when it is set (bit = 1) and can mean poll or final. It means *poll* when the frame is sent by a primary station to a secondary (when the address field contains the address of the receiver). It means *final* when the frame is sent by a secondary to a primary.

### Control Field for S-Frames

Supervisory frames are used for flow and error control whenever piggybacking is either impossible or inappropriate. S-frames do not have information fields. If the first 2 bits of the control field is 10, this means the frame is an S-frame. The last 3 bits, called  $N(R)$ , corresponds to the acknowledgment number (ACK) or negative acknowledgment number (NAK) depending on the type of S-frame. The 2 bits called code is used to define the type of S-frame itself. With 2 bits, we can have four types of S-frames, as described below:



o **Receive ready (RR)**. If the value of the code subfield is 00, it is an RR S-frame. This kind of frame acknowledges the receipt of a safe and sound frame or group of frames. In this case, the value  $N(R)$  field defines the acknowledgment number.

o **Receive not ready (RNR)**. If the value of the code subfield is 10, it is an RNR S-frame. This kind of frame is an RR frame with additional functions. It acknowledges the receipt of a frame or group of frames, and it announces that the receiver is busy and cannot receive more frames. It acts as a kind of congestion control mechanism by asking the sender to slow down. The value of  $NCR$  is the acknowledgment number.

o **Reject (REJ)**. If the value of the code subfield is 01, it is a REJ S-frame. This is a NAK frame, but not like the one used for Selective Repeat ARQ. It is a NAK that can be used in *Go-Back-N* ARQ to improve the efficiency of the process by informing the sender, before the sender time expires, that the last frame is lost or damaged. The value of  $NCR$  is the negative acknowledgment number.

o **Selective reject (SREJ)**. If the value of the code subfield is 11, it is an SREJ S-frame. This is a NAK frame used in Selective Repeat ARQ. Note that the HDLC Protocol uses the term *selective reject* instead of *selective repeat*. The value of  $N(R)$  is the negative acknowledgment number.

### ***Control Field for V-Frames***

Unnumbered frames are used to exchange session management and control information between connected devices. Unlike S-frames, U-frames contain an information field, but one used for system management information, not user data. As with S-frames, however, much of the information carried by U-frames is contained in codes included in the control field. U-frame codes are divided into two sections: a 2-bit prefix before the PtF bit and a 3-bit suffix after the PtF bit. Together, these two segments (5 bits) can be used to create up to 32 different types of U-frames.

## **THE OSI MODEL**

The OSI model is based on a proposal developed by the International Standards Organization (ISO) as a first step toward international standardization of the protocols used in the various layers (Day and Zimmermann, 1983). It was revised in 1995 (Day, 1995). The model is called the ISO-OSI (Open Systems Interconnection) Reference Model because it deals with connecting open systems—that is, systems that are open for communication with other systems.

The OSI model is a layered framework for the design of network systems that allows communication between all types of computer systems. It consists of seven separate but related layers, each of which defines a part of the process of moving information across a network.

---

*Seven layers of the OSI model*

---

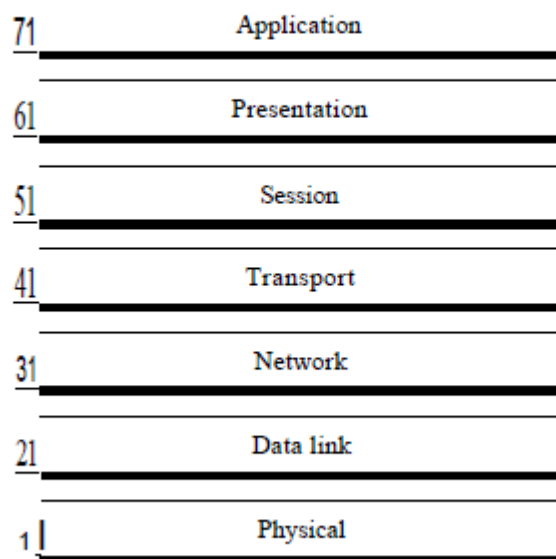

The OSI model is composed of seven ordered layers: physical (layer 1), data link (layer 2), network (layer 3), transport (layer 4), session (layer 5), presentation (layer 6), and application (layer 7). Figure below shows the layers involved when a message is sent from device A to device B. As the message travels from A to B, it may pass through many intermediate nodes. These intermediate nodes usually involve only the first three layers of the OSI model.

## **LAYERS IN THE OSI MODEL**

### **1. Physical Layer**

The physical layer coordinates the functions required to carry a bit stream over a physical medium. It deals with the mechanical and electrical specifications of the interface and transmission medium. It also defines the procedures and functions that physical devices and interfaces have to perform for transmission to occur.

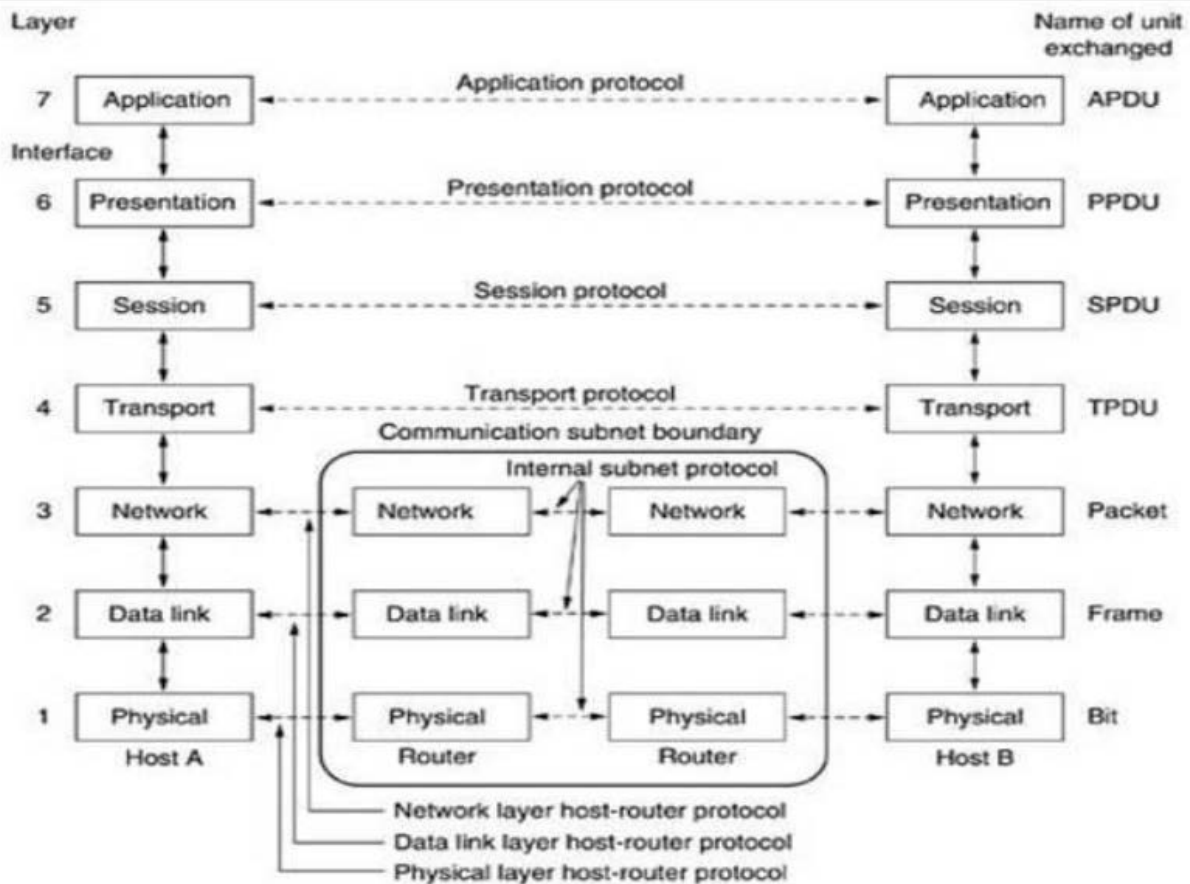

The physical layer is also concerned with the following:

- o **Physical characteristics of interfaces and medium.** The physical layer defines the characteristics of the interface between the devices and the transmission medium. It also defines the type of transmission medium.
- o **Representation of bits.** The physical layer data consists of a stream of bits (sequence of Os or 1s) with no interpretation. To be transmitted, bits must be encoded into signals--electrical or optical. The physical layer defines the type of encoding .
- o **Data rate.** The transmission rate--the number of bits sent each second--is also defined by the physical layer. In other words, the physical layer defines the duration of a bit, which is how long it lasts.
- o **Synchronization of bits.** The sender and receiver not only must use the same bit rate but also must be synchronized at the bit level. In other words, the sender and the receiver clocks must be synchronized.

- o **Line configuration.** The physical layer is concerned with the connection of devices to the media. In a point-to-point configuration, two devices are connected through a dedicated link. In a multipoint configuration, a link is shared among several devices.
- o **Physical topology.** The physical topology defines how devices are connected to make a network. Devices can be connected by using a mesh topology (every device is connected to every other device), a star topology (devices are connected through a central device), a ring topology (each device is connected to the next, forming a ring), a bus topology (every device is on a common link), or a hybrid topology (this is a combination of two or more topologies).
- o **Transmission mode.** The physical layer also defines the direction of transmission between two devices: simplex, half-duplex, or full-duplex. In simplex mode, only one device can send; the other can only receive. The simplex mode is a one-way communication. In the half-duplex mode, two devices can send and receive, but not at the same time. In a full-duplex (or simply duplex) mode, two devices can send and receive at the same time.

## **2. Data Link Layer**

The data link layer transforms the physical layer, a raw transmission facility, to a reliable link. It makes the physical layer appear error-free to the upper layer (network layer).

Other responsibilities of the data link layer include the following:

- o **Framing.** The data link layer divides the stream of bits received from the network layer into manageable data units called frames.
- o **Physical addressing.** If frames are to be distributed to different systems on the network, the data link layer adds a header to the frame to define the sender and/or receiver of the frame. If the frame is intended for a system outside the sender's network, the receiver address is the address of the device that connects the network to the next one.
- o **Flow control.** If the rate at which the data are absorbed by the receiver is less than the rate at which data are produced in the sender, the data link layer imposes a flow control mechanism to avoid overwhelming the receiver.
- o **Error control.** The data link layer adds reliability to the physical layer by adding mechanisms to detect and retransmit damaged or lost frames. It also uses a mechanism to recognize duplicate frames. Error control is normally achieved through a trailer added to the end of the frame.
- o **Access control.** When two or more devices are connected to the same link, data link layer protocols are necessary to determine which device has control over the link at any given time.

### **3. Network Layer**

The network layer is responsible for the source-to-destination delivery of a packet, possibly across multiple networks (links). Whereas the data link layer oversees the delivery of the packet between two systems on the same network (links), the network layer ensures that each packet gets from its point of origin to its final destination. If two systems are connected to the same link, there is usually no need for a network layer. However, if the two systems are attached to different networks (links) with connecting devices between the networks (links), there is often a need for the network layer to accomplish source-to-destination delivery.

Other responsibilities of the network layer include the following:

- o **Logical addressing.** The physical addressing implemented by the data link layer handles the addressing problem locally. If a packet passes the network boundary, we need another addressing system to help distinguish the source and destination systems. The network layer adds a header to the packet coming from the upper layer that, among other things, includes the logical addresses of the sender and receiver.
- o **Routing.** When independent networks or links are connected to create *intemetworks* (network of networks) or a large network, the connecting devices (called *routers* or *switches*) route or switch the packets to their final destination. One of the functions of the network layer is to provide this mechanism.

### **4. Transport Layer**

The transport layer is responsible for process-to-process delivery of the entire message. A process is an application program running on a host. Whereas the network layer oversees source-to-destination delivery of individual packets, it does not recognize any relationship between those packets. It treats each one independently, as though each piece belonged to a separate message, whether or not it does. The transport layer, on the other hand, ensures that the whole message arrives intact and in order, overseeing both error control and flow control at the source-to-destination level.

Other responsibilities of the transport layer include the following:

- o **Service-point addressing.** Computers often run several programs at the same time. For this reason, source-to-destination delivery means delivery not only from one computer to the next but also from a specific process (running program) on one computer to a specific process (running program) on the other. The transport layer header must therefore include a type of address called

a *service-point address* (or port address). The network layer gets each packet to the correct computer; the transport layer gets the entire message to the correct process on that computer.

- o **Segmentation and reassembly.** A message is divided into transmittable segments, with each segment containing a sequence number. These numbers enable the transport layer to reassemble the message correctly upon arriving at the destination and to identify and replace packets that were lost in transmission.

- o **Connection control.** The transport layer can be either connectionless or connection oriented. A connectionless transport layer treats each segment as an independent packet and delivers it to the transport layer at the destination machine. A connection oriented transport layer makes a connection with the transport layer at the destination machine first before delivering the packets. After all the data are transferred, the connection is terminated.

- o **Flow control.** Like the data link layer, the transport layer is responsible for flow control. However, flow control at this layer is performed end to end rather than across a single link.

- o **Error control.** Like the data link layer, the transport layer is responsible for error control. However, error control at this layer is performed process-to-process rather than across a single link. The sending transport layer makes sure that the entire message arrives at the receiving transport layer without error (damage, loss, or duplication). Error correction is usually achieved through retransmission.

## **5. Session Layer**

The services provided by the first three layers (physical, data link, and network) are not sufficient for some processes. The session layer is the network *dialog controller*. It establishes, maintains, and synchronizes the interaction among communicating systems.

Specific responsibilities of the session layer include the following:

- o **Dialog control.** The session layer allows two systems to enter into a dialog. It allows the communication between two processes to take place in either half duplex (one way at a time) or full-duplex (two ways at a time) mode.

- o **Synchronization.** The session layer allows a process to add checkpoints, or synchronization points, to a stream of data.

## **6. Presentation Layer**

The presentation layer is concerned with the syntax and semantics of the information exchanged between two systems.

Specific responsibilities of the presentation layer include the following:

- o **Translation.** The processes (running programs) in two systems are usually exchanging information in the form of character strings, numbers, and so on. The information must be changed to bit streams before being transmitted. Because different computers use different encoding systems, the presentation layer is responsible for interoperability between these different encoding methods. The presentation layer at the sender changes the information from its sender-dependent format into a common format. The presentation layer at the receiving machine changes the common format into its receiver-dependent format.
- o **Encryption.** To carry sensitive information, a system must be able to ensure privacy. Encryption means that the sender transforms the original information to another form and sends the resulting message out over the network. Decryption reverses the original process to transform the message back to its original form.
- o **Compression.** Data compression reduces the number of bits contained in the information. Data compression becomes particularly important in the transmission of multimedia such as text, audio, and video.

## **7. Application Layer**

The application layer enables the user, whether human or software, to access the network. It provides user interfaces and support for services such as electronic mail, remote file access and transfer, shared database management, and other types of distributed information services.

Specific services provided by the application layer include the following:

- o **Network virtual terminal.** A network virtual terminal is a software version of a physical terminal, and it allows a user to log on to a remote host.
- o **File transfer, access, and management.** This application allows a user to access files in a remote host (to make changes or read data), to retrieve files from a remote computer for use in the local computer, and to manage or control files in a remote computer locally.
- o **Mail services.** This application provides the basis for e-mail forwarding and storage.
- o **Directory services.** This application provides distributed database sources and access for global information about various objects and services.

## TCP/IP PROTOCOL SUITE

The TCP/IP protocol suite was developed prior to the OSI model. Therefore, the layers in the TCP/IP protocol suite do not exactly match those in the OSI model. The original TCP/IP protocol suite was defined as having four layers: host-to-network, internet, transport, and application. However, when TCP/IP is compared to OSI, we can say that the host-to-network layer is equivalent to the combination of the physical and data link layers. The internet layer is equivalent to the network layer, and the application layer is roughly doing the job of the session, presentation, and application layers with the transport layer in TCP/IP taking care of part of the duties of the session layer.

*TCP/IP* is a hierarchical protocol made up of interactive modules, each of which provides a specific functionality; however, the modules are not necessarily interdependent. Whereas the OSI model specifies which functions belong to each of its layers, the layers of the *TCP/IP* protocol suite contain relatively independent protocols that can be mixed and matched depending on the needs of the system. The term *hierarchical* means that each upper-level protocol is supported by one or more lower-level protocols.

At the transport layer, *TCP/IP* defines three protocols: Transmission Control Protocol (TCP), User Datagram Protocol (UDP), and Stream Control Transmission Protocol (SCTP). At the network layer, the main protocol defined by TCP/IP is the Internetworking Protocol (IP); there are also some other protocols that support data movement in this layer.

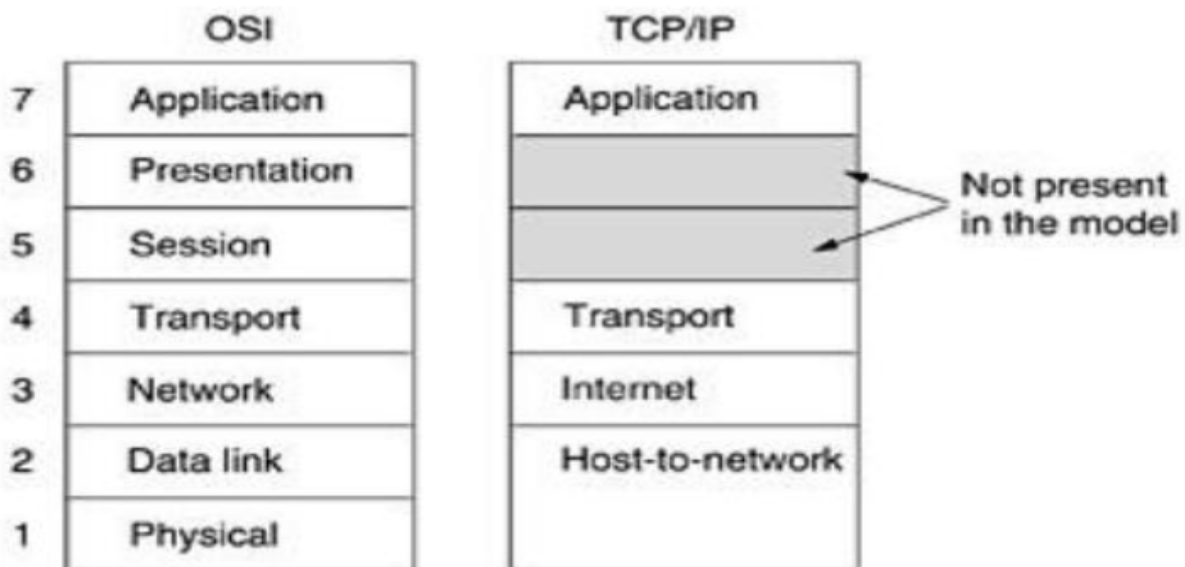



### **1. Host-to-Network Layer:**

The TCP/IP reference model does not really say much about what happens here, except to point out that the host has to connect to the network using some protocol so it can send IP packets to it. This protocol is not defined and varies from host to host and network to network.

### **2. Internet Layer:**

Its job is to permit hosts to inject packets into any network and have them travel independently to the destination (potentially on a different network). They may even arrive in a different order than they were sent, in which case it is the job of higher layers to rearrange them, if in-order delivery is desired.

The internet layer defines an official packet format and protocol called IP (Internet Protocol). The job of the internet layer is to deliver IP packets where they are supposed to go. Packet routing is clearly the major issue here, as is avoiding congestion.

### **3. The Transport Layer:**

The layer above the internet layer in the TCP/IP model is now usually called the transport layer. It is designed to allow peer entities on the source and destination hosts to carry on a conversation, just as in the OSI transport layer. Two end-to-end transport protocols have been defined here. The first one, TCP (Transmission Control Protocol), is a reliable connection-oriented protocol that allows a byte stream originating on one machine to be delivered without error on any other machine in the internet. It fragments the incoming byte stream into discrete messages and passes each one on to the internet layer. At the destination, the receiving TCP process reassembles the received messages into the output stream. TCP also handles flow control to make sure a fast sender cannot swamp a slow receiver with more messages than it can handle. The second protocol in this layer, UDP (User Datagram Protocol), is an unreliable, connectionless protocol for applications that do not want TCP's sequencing or flow control and wish to provide their own. It is also widely used for one-shot, client-server-type request-reply queries and applications in which prompt delivery is more important than accurate delivery, such as transmitting speech or video.

### **4. The Application Layer:**

The TCP/IP model does not have session or presentation layers. On top of the transport layer is the application layer. It contains all the higher-level protocols. The early ones included virtual terminal (TELNET), file transfer (FTP), and electronic mail (SMTP). The virtual terminal

protocol allows a user on one machine to log onto a distant machine and work there. The file transfer protocol provides a way to move data efficiently from one machine to another. Electronic mail was originally just a kind of file transfer, but later a specialized protocol (SMTP) was developed for it. Many other protocols have been added to these over the years: the Domain Name System (DNS) for mapping host names onto their network addresses, NNTP, the protocol for moving USENET news articles around, and HTTP, the protocol for fetching pages on the World Wide Web, and many others.

### **Comparison of the OSI and TCP/IP Reference Models:**

The OSI and TCP/IP reference models have much in common. Both are based on the concept of a stack of independent protocols. Also, the functionality of the layers is roughly similar. For example, in both models the layers up through and including the transport layer are there to provide an end-to-end, network-independent transport service to processes wishing to communicate. These layers form the transport provider. Again in both models, the layers above transport are application-oriented users of the transport service. Despite these fundamental similarities, the two models also have many differences. Three concepts are central to the OSI model:

1. Services.
2. Interfaces.
3. Protocols.

Probably the biggest contribution of the OSI model is to make the distinction between these three concepts explicit. Each layer performs some services for the layer above it. The service definition tells what the layer does, not how entities above it access it or how the layer works. It defines the layer's semantics.

A layer's interface tells the processes above it how to access it. It specifies what the parameters are and what results to expect. It, too, says nothing about how the layer works inside.

Finally, the peer protocols used in a layer are the layer's own business. It can use any protocols it wants to, as long as it gets the job done (i.e., provides the offered services). It can also change them at will without affecting software in higher layers.

The TCP/IP model did not originally clearly distinguish between service, interface, and protocol, although people have tried to retrofit it after the fact to make it more OSI-like. For example, the

only real services offered by the internet layer are SEND IP PACKET and RECEIVE IP PACKET.

As a consequence, the protocols in the OSI model are better hidden than in the TCP/IP model and can be replaced relatively easily as the technology changes. Being able to make such changes is one of the main purposes of having layered protocols in the first place. The OSI reference model was devised before the corresponding protocols were invented. This ordering means that the model was not biased toward one particular set of protocols, a fact that made it quite general. The downside of this ordering is that the designers did not have much experience with the subject and did not have a good idea of which functionality to put in which layer.

Another difference is in the area of connectionless versus connection-oriented communication. The OSI model supports both connectionless and connection-oriented communication in the network layer, but only connection-oriented communication in the transport layer, where it counts (because the transport service is visible to the users). The TCP/IP model has only one mode in the network layer (connectionless) but supports both modes in the transport layer, giving the users a choice. This choice is especially important for simple request-response protocols.

## **CONNECTING DEVICES**

### **1. Repeaters**

A repeater is a device that operates only in the physical layer. Signals that carry information within a network can travel a fixed distance before attenuation endangers the integrity of the data. A repeater receives a signal and, before it becomes too weak or corrupted, regenerates the original bit pattern. The repeater then sends the refreshed signal. A repeater can extend the physical length of a LAN, as shown in Figure 15.2.

---

**Figure 15.2** *A repeater connecting two segments of a LAN*

---

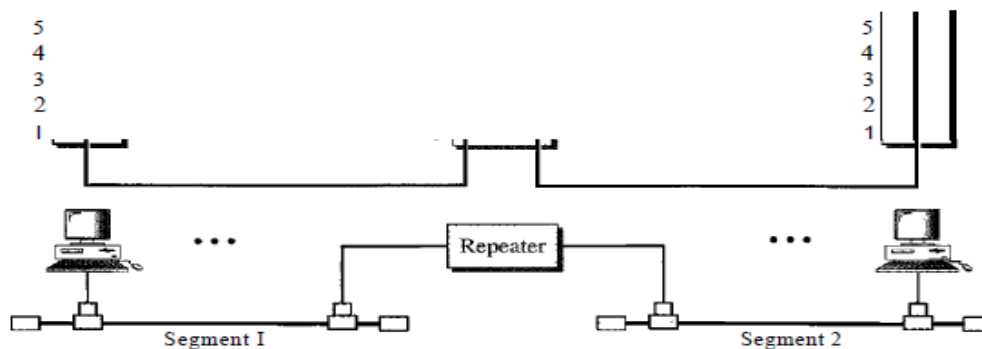

A repeater does not actually connect two LANs; it connects two segments of the same LAN. The segments connected are still part of one single LAN. A repeater is not a device that can connect two LANs of different protocols.

It is tempting to compare a repeater to an amplifier, but the comparison is inaccurate. An amplifier cannot discriminate between the intended signal and noise; it amplifies equally everything fed into it. A repeater does not amplify the signal; it regenerates the signal. When it receives a weakened or corrupted signal, it creates a copy, bit for bit, at the original strength.

## **2. Bridges or Link Layer Switches**

A bridge or Link layer switch (or simply Switch) operates in both the physical and the data link layer. As a physical layer device, it regenerates the signal it receives. As a data link layer device, the bridge can check the physical (MAC) addresses (source and destination) contained in the frame. A bridge has filtering capability. It can check the destination address of a frame and decide if the frame should be forwarded or dropped. If the frame is to be forwarded, the decision must specify the port. A bridge has a table that maps addresses to ports.

Let us give an example. In Figure 15.5, two LANs are connected by a bridge. If a frame destined for station 712B13456142 arrives at port 1, the bridge consults its table to find the departing port. According to its table, frames for 712B13456142 leave through port 1; therefore, there is no need for forwarding, and the frame is dropped. On the other hand, if a frame for 712B13456141 arrives at port 2, the departing port is port 1 and the frame is forwarded. In the first case, LAN 2 remains free of traffic; in the second case, both LANs have traffic. In our example, we show a two-port bridge; in reality a bridge usually has more ports.

*Figure 15.5 A bridge connecting two LANs*

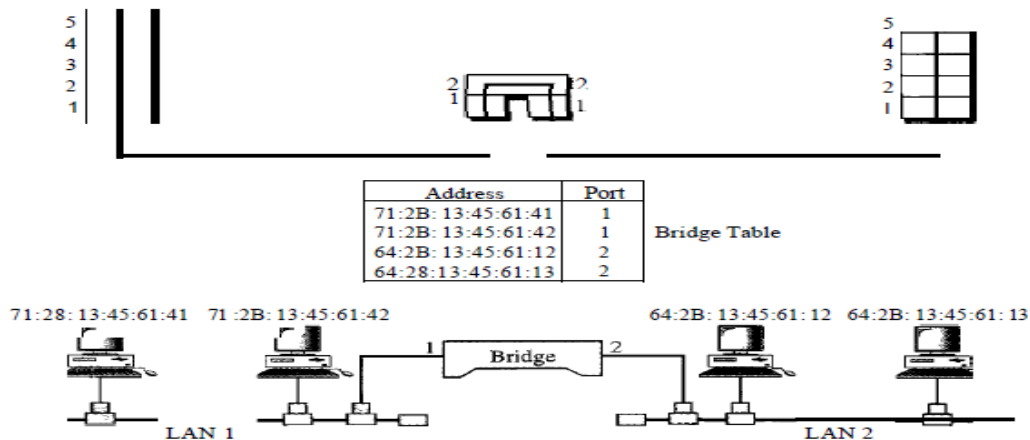

### **3. Hubs**

A Hub is a device that operates only in the physical layer. Signals that carry information within a network can travel a fixed distance before attenuation endangers the integrity of the data. A repeater receives a signal and, before it becomes too weak or corrupted, regenerates and retimes the original bit pattern. The repeater then sends the refreshed signal. In a star topology, a repeater is a multiport device, often called as hub, that can be used to serve as the connecting point and at the same time function as a repeater. Figure below shows that when a packet from station A to station B arrives at the hub, the signal representing the frame is regenerated to remove any possible corrupting noise, but the hub forwards the packet from all outgoing ports except the one from which the signal was received. In other words, the frame is broadcast. All the stations in the LAN receive the frame, but only station B keeps it. The rest of the stations discard it.

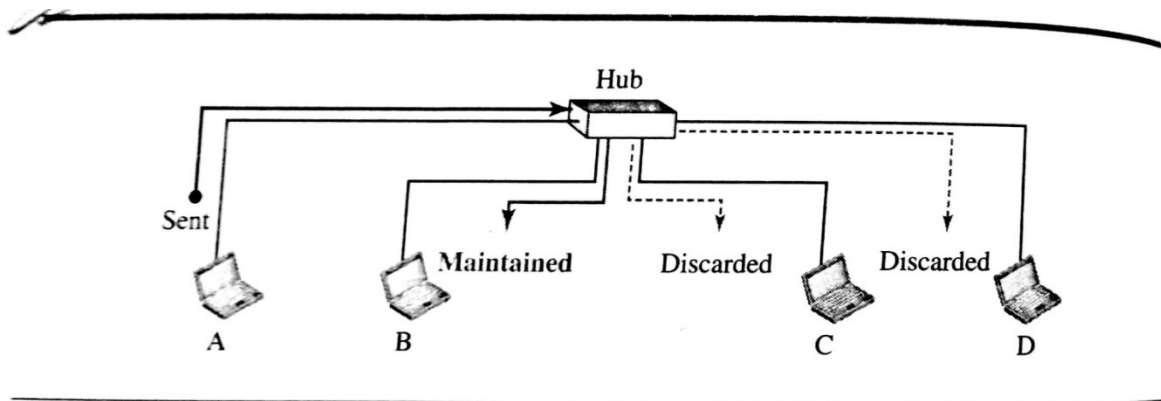

A hub is a physical layer device. They do not have a link layer address and they do not check the link layer address of the received frame. They just regenerate the corrupted bits and send them out from every port.

### **4. Routers**

A router is a three-layer device that routes packets based on their logical addresses (host-to-host addressing). A router normally connects LANs and WANs in the Internet and has a routing table that is used for making decisions about the route. The routing tables are normally dynamic and are updated using routing protocols. Figure 15.11 shows a part of the Internet that uses routers to connect LANs and WANs.

---

Figure 15.11 *Routers connecting independent LANs and WANs*

---

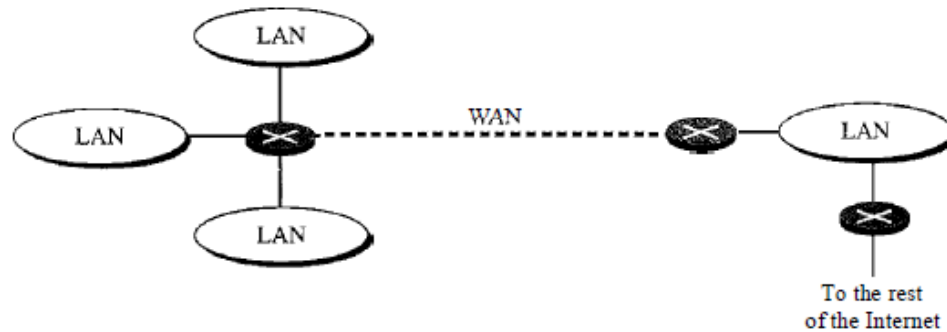

---

A router is a three layer device. It operates in the physical, data link and network layers. As a physical layer device, it regenerates the signal it receives. As a link layer device the router checks the physical addresses contained in the packet. As a network layer device , a router checks the network layer addresses. A router can connect networks. In other words, a router is an internetworking device; it connects independent networks to form an internetwork.

There are three major differences between a router and a repeater or switch.

- a. A router has a physical and logical address for each of its interfaces.
- b. A router acts only on those packets in which the link layer destination address matches the address of the interface at which the packet arrives.
- c. A router changes the link layer address of the packet when it forwards the packet.

## **5. Gateways**

A gateway is normally a computer that operates in all five layers of the Internet or seven layers of OSI model. A gateway takes an application message, reads it, and interprets it. This means that it can be used as a connecting device between two internetworks that use different models. For example, a network designed to use the OSI model can be connected to another network using the Internet model. The gateway connecting the two systems can take a frame as it arrives from the first system, move it up to the OSI application layer, and remove the message.

## ETHERNET ADDRESS

### *Ethernet or physical or MAC address*

Each station on an Ethernet network (such as a PC, workstation, or printer) has its own network interface card (NIC). The NIC fits inside the station and provides the station with a 6-byte physical address. As shown in Figure 13.6, the Ethernet address is 6 bytes (48 bits), normally written in hexadecimal notation, with a colon between the bytes.

---

Figure 13.6 *Example of an Ethernet address in hexadecimal notation*

---

06:01 :02:01:2C:4B

---

6 bytes = 12 hex digits = 48 bits

---

**Unicast, Multicast, and Broadcast Addresses:** A source address is always a unicast address-the frame comes from only one station. The destination address, however, can be unicast, multicast, or broadcast. If the least significant bit of the first byte in a destination address is 0, the address is unicast; otherwise, it is multicast. A unicast destination address defines only one recipient; the relationship between the sender and the receiver is one-to-one. A multicast destination address defines a group of addresses; the relationship between the sender and the receivers is one-to-many. The broadcast address is a special case of the multicast address; the recipients are all the stations on the LAN. A broadcast destination address is forty-eight 1's.

For Example:

- a)- 4A:30:10:21:10:1A - This is a unicast address because A in binary is 1010 (even).
- b)- 47:20:1B:2E:08:EE - This is a multicast address because 7 in binary is 0111 (odd).
- c)- FF:FF:FF:FF:FF:FF - This is a broadcast address because all digits are F's.

The way the addresses are sent out on line is different from the way they are written in hexadecimal notation. The transmission is left-to-right, byte by byte; however, for each byte, the least significant bit is sent first and the most significant bit is sent last. This means that the bit that defines an address as unicast or multicast arrives first at the receiver.

# **INTERNET PROTOCOL ADDRESS**

## **IP Address or Network address or logical address**

An **IPv4** address is a 32-bit address that *uniquely* and *universally* defines the connection of a device (for example, a computer or a router) to the Internet. IPv4 addresses are unique. They are unique in the sense that each address defines one, and only one, connection to the Internet. Two devices on the Internet can never have the same address at the same time. The IPv4 addresses are universal in the sense that the addressing system must be accepted by any host that wants to be connected to the Internet.

## **Address Space**

A protocol such as IPv4 that defines addresses has an address space. An address space is the total number of addresses used by the protocol. If a protocol uses  $N$  bits to define an address, the address space is  $2^N$  because each bit can have two different values (0 or 1) and  $N$  bits can have  $2^N$  values. IPv4 uses 32-bit addresses, which means that the address space is  $2^{32}$  or 4,294,967,296 (more than 4 billion). This means that, theoretically, if there were no restrictions, more than 4 billion devices could be connected to the Internet.

## **Notations**

There are two prevalent notations to show an IPv4 address: binary notation and dotted decimal notation.

### ***Binary Notation***

In binary notation, the IPv4 address is displayed as 32 bits. Each octet is often referred to as a byte. So it is common to hear an IPv4 address referred to as a 32-bit address or a 4-byte address. The following is an example of an IPv4 address in binary notation:

01110101 10010101 00011101 00000010

### ***Dotted-Decimal Notation***

To make the IPv4 address more compact and easier to read, Internet addresses are usually written in decimal form with a decimal point (dot) separating the bytes. The following is the dotted decimal notation of the above address:

117.149.29.2

Figure 19.1 shows an IPv4 address in both binary and dotted-decimal notation. Note that because each byte (octet) is 8 bits, each number in dotted-decimal notation is a value ranging from 0 to 255.



Figure 19.1 Dotted-decimal notation and binary notation for an IPv4 address

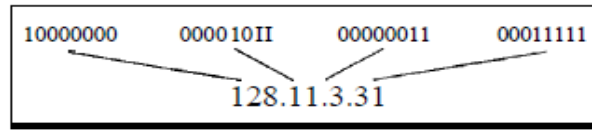

## IP Address Classes:

IPv4 addressing, at its inception, used the concept of classes. This architecture is called classful addressing. In classful addressing, the address space is divided into five classes: A, B, C, D, and E. Each class occupies some part of the address space. We can find the class of an address when given the address in binary notation or dotted-decimal notation. If the address is given in binary notation, the first few bits can immediately tell us the class of the address. If the address is given in decimal-dotted notation, the first byte defines the class. Both methods are shown in Figure 19.2.

Figure 19.2 Finding the classes in binary and dotted-decimal notation

	First byte	Second byte	Third byte	Fourth byte
Class A	0			
Class B	10			
Class C	110			
Class D	1110			
Class E	1111			

a. Binary notation

	First byte	Second byte	Third byte	Fourth byte
Class A	0-127			
Class B	128-191			
Class C	192-223			
Class D	224-239			
Class E	240-255			

b. Dotted-decimal notation

## Classes and Blocks

One problem with classful addressing is that each class is divided into a fixed number of blocks with each block having a fixed size as shown in Table 19.1.

Table 19.1 Number of blocks and block size in classful IPv4 addressing

Class	Number of Blocks	Block Size	Application
A	128	16,777,216	Unicast
B	16,384	65,536	Unicast
C	2,097,152	256	Unicast
D	1	268,435,456	Multicast
E	1	268,435,456	Reserved

Previously, when an organization requested a block of addresses, it was granted one in class A, B, or C. Class A addresses were designed for large organizations with a large number of attached hosts or routers. Class B addresses were designed for midsize organizations with tens of thousands of attached hosts or routers. Class C addresses were designed for small organizations with a small number of attached hosts or routers.

We can see the flaw in this design. A block in class A address is too large for almost any organization. This means most of the addresses in class A were wasted and were not used. A block in class B is also very large, probably too large for many of the organizations that received a class B block. A block in class C is probably too small for many organizations. Class D addresses were designed for multicasting. Each address in this class is used to define one group of hosts on the Internet. The Internet authorities wrongly predicted a need for 268,435,456 groups. This never happened and many addresses were wasted here too. And lastly, the class E addresses were reserved for future use; only a few were used, resulting in another waste of addresses.

## **COMMON NETWORK APPLICATIONS**

### **1. TELNET**

TELNET is an abbreviation for *TErминаL NETwork*. It is the standard TCP/IP protocol for virtual terminal service as proposed by the International Organization for Standards (ISO). TELNET enables the establishment of a connection to a remote system in such a way that the local terminal appears to be a terminal at the remote system. TELNET was designed at a time when most operating systems, such as UNIX, were operating in a timesharing environment. In such an environment, a large computer supports multiple users. The interaction between a user and the computer occurs through a terminal, which is usually a combination of keyboard, monitor, and mouse. Even a microcomputer can simulate a terminal with a terminal emulator.

#### ***Logging***

In a timesharing environment, users are part of the system with some right to access resources. Each authorized user has an identification and probably, a password. The user identification defines the user as part of the system. To access the system, the user logs into the system with a user id or log-in name. The system also includes password checking to prevent an unauthorized user from accessing the resources. Figure 26.1 shows the logging process.

Figure 26.1 Local and remote log-in

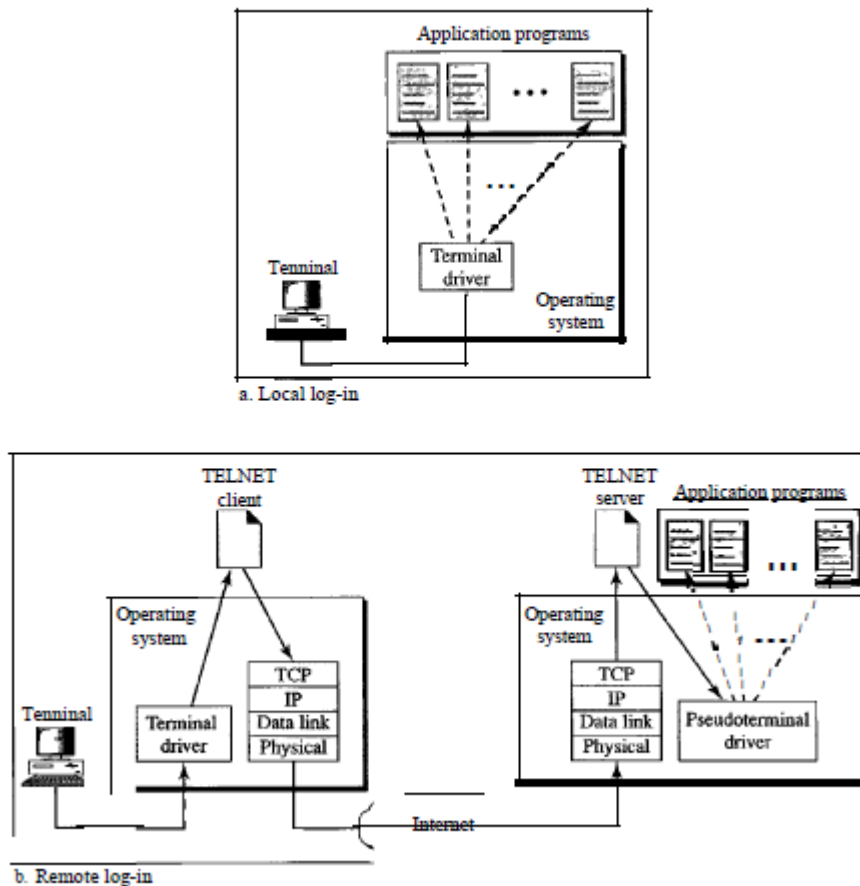

When a user logs into a local timesharing system, it is called local log-in. As a user types at a terminal or at a workstation running a terminal emulator, the keystrokes are accepted by the terminal driver. The terminal driver passes the characters to the operating system. The operating system, in turn, interprets the combination of characters and invokes the desired application program or utility. When a user wants to access an application program or utility located on a remote machine, she performs remote log-in. Here the TELNET client and server programs come into use. The user sends the keystrokes to the terminal driver, where the local operating system accepts the characters but does not interpret them. The characters are sent to the TELNET client, which transforms the characters to a universal character set called *network virtual terminal (NVT) characters* and delivers them to the local *TCP/IP* protocol stack. The commands or text, in NVT form, travel through the Internet and arrive at the TCP/IP stack at the remote machine. Here the characters are delivered to the operating system and passed to the TELNET

server, which changes the characters to the corresponding characters understandable by the remote computer. However, the characters cannot be passed directly to the operating system because the remote operating system is not designed to receive characters from a TELNET server: It is designed to receive characters from a terminal driver. The solution is to add a piece of software called a *pseudoterminal driver* which pretends that the characters are coming from a terminal. The operating system then passes the characters to the appropriate application program.

## **2. ELECTRONIC MAIL**

One of the most popular Internet services is electronic mail (e-mail). The designers of the Internet probably never imagined the popularity of this application program. At the beginning of the Internet era, the messages sent by electronic mail were short and consisted of text only; they let people exchange quick memos. Today, electronic mail is much more complex. It allows a message to include text, audio, and video. It also allows one message to be sent to one or more recipients.

### ***Architecture***

#### **User Agent**

The first component of an electronic mail system is the user agent. It provides service to the user to make the process of sending and receiving a message easier.

#### ***Services Provided by a User Agent***

A user agent is a software package (program) that composes, reads, replies to, and forwards messages. It also handles mailboxes. Figure 26.11 shows the services of a typical user agent.

---

**Figure 26.11** *Services of user agent*

---

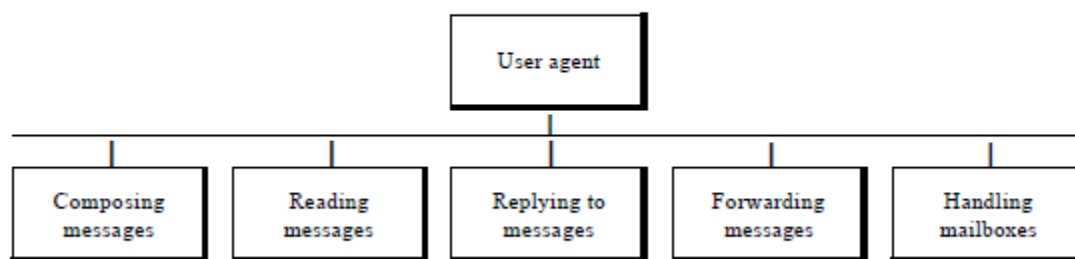

#### **Composing Messages**

A user agent helps the user compose the e-mail message to be sent out. Most user agents provide a template on the screen to be filled in by the user. Some even have a built-in editor that can do

spell checking, grammar checking, and other tasks expected from a sophisticated word processor. A user, of course, could alternatively use his or her favorite text editor or word processor to create the message and import it, or cut and paste it, into the user agent template.

### **Reading Messages**

The second duty of the user agent is to read the incoming messages. When a user invokes a user agent, it first checks the mail in the incoming mailbox. Most user agents show a one-line summary of each received mail. Each e-mail contains the following fields.

1. A number field.
2. A flag field that shows the status of the mail such as new, already read but not replied to, or read and replied to.
3. The size of the message.
4. The sender.
5. The optional subject field.

### **Replying to Messages**

After reading a message, a user can use the user agent to reply to a message. A user agent usually allows the user to reply to the original sender or to reply to all recipients of the message. The reply message may contain the original message and the new message.

### **Forwarding Messages**

*Replying* is defined as sending a message to the sender or recipients of the copy. *Forwarding* is defined as sending the message to a third party. A user agent allows the receiver to forward the message, with or without extra comments, to a third party.

### ***Handling Mailboxes***

A user agent normally creates two mailboxes: an inbox and an outbox. Each box is a file with a special format that can be handled by the user agent. The inbox keeps all the received e-mails until they are deleted by the user. The outbox keeps all the sent e-mails until the user deletes them. Most user agents today are capable of creating customized mailboxes.

### **User Agent Types**

There are two types of user agents: command-driven and GUI-based.

**Command-Driven:** Command-driven user agents belong to the early days of electronic mail. They are still present as the underlying user agents in servers. A command-driven user agent normally accepts a one-character command from the keyboard to perform its task. For example,

a user can type the character r, at the command prompt, to reply to the sender of the message, or type the character R to reply to the sender and all recipients. Some examples of command-driven user agents are *mail*, *pine*, and *elm*.

**GUI-Based:** Modern user agents are GUI-based. They contain graphical-user interface (GUI) components that allow the user to interact with the software by using both the keyboard and the mouse. They have graphical components such as icons, menu bars, and windows that make the services easy to access. Some examples of GUI-based user agents are Eudora, Microsoft's Outlook, and Netscape.

### Addresses

To deliver mail, a mail handling system must use an addressing system with unique addresses. In the Internet, the address consists of two parts: a local part and a domain name, separated by an @ sign

**Local Part:** The local part defines the name of a special file, called the user mailbox, where all the mail received for a user is stored for retrieval by the message access agent.

**Domain Name:** The second part of the address is the domain name. An organization usually selects one or more hosts to receive and send e-mail; the hosts are sometimes called *mail servers* or *exchangers*. The domain name assigned to each mail exchanger either comes from the DNS database or is a logical name (for example, the name of the organization).

### 3. SMTP

The actual mail transfer is done through message transfer agents. To send mail, a system must have the client MTA, and to receive mail, a system must have a server MTA. The formal protocol that defines the MTA client and server in the Internet is called the Simple Mail Transfer Protocol (SMTP).

---

Figure 26.16 SMTP range

---

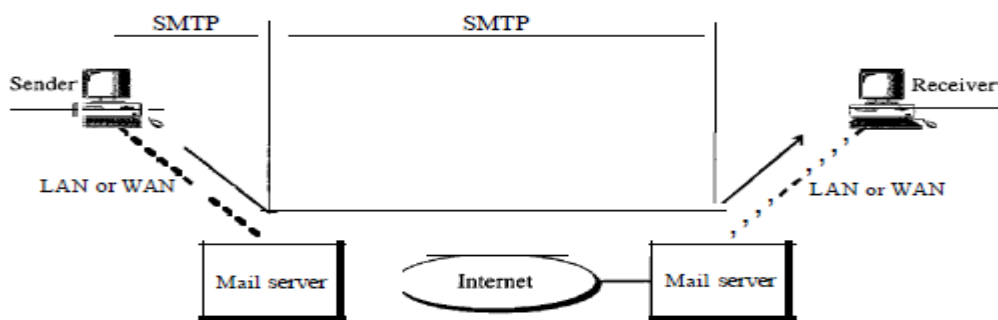

SMTP is used two times, between the sender and the sender's mail server and between the two mail servers. SMTP simply defines how commands and responses must be sent back and forth.

### **Commands and Responses**

SMTP uses commands and responses to transfer messages between an MTA client and an MTA server (see Figure 26.17).

**Figure 26.17** *Commands and responses*

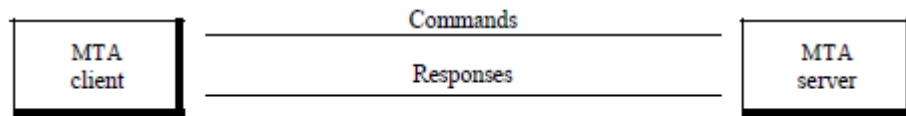

**Commands:** Commands are sent from the client to the server. The format of a command is shown in Figure 26.18. It consists of a keyword followed by zero or more arguments. SMTP defines 14 commands. The first five are mandatory; every implementation must support these five commands. The next three are often used and highly recommended. The last six are seldom used.

**Figure 26.18** *Commandformat*

Keyword: argument(s)

The commands are listed in Table 26.7.

**Table 26.7** *Commands*

<i>Keyword</i>	<i>Argument(s)</i>
HELO	Sender's host name
MAIL FROM	Sender of the message
RCPT TO	Intended recipient of the message
DATA	Body of the mail
QUIT	
RSET	
VERFY	Name of recipient to be verified
NOOP	
TURN	
EXPN	Mailing list to be expanded
HELP	Command name

**Responses:** Responses are sent from the server to the client. A response is a three digit code that may be followed by additional textual information. Table 26.8 lists some of the responses.

**Table 26.8** *Responses*

<i>Code</i>	<i>Description</i>
<b>Positive Completion Reply</b>	
211	System status or help reply
214	Help message
220	Service ready
221	Service closing transmission channel
250	Request command completed
251	User not local; the message will be forwarded
<b>Positive Intermediate Reply</b>	
354	Start mail input

### ***Mail Transfer Phases***

The process of transferring a mail message occurs in three phases: connection establishment, mail transfer, and connection termination.

## **4. POP3**

Post Office Protocol, version 3 (POP3) is simple and limited in functionality. The client POP3 software is installed on the recipient computer; the server POP3 software is installed on the mail server. Mail access starts with the client when the user needs to download e-mail from the mailbox on the mail server. The client opens a connection to the server on TCP port 110. It then sends its user name and password to access the mailbox. The user can then list and retrieve the mail messages, one by one.

POP3 has two modes: the delete mode and the keep mode. In the delete mode, the mail is deleted from the mailbox after each retrieval. In the keep mode, the mail remains in the mailbox after retrieval. The delete mode is normally used when the user is working at her permanent computer and can save and organize the received mail after reading or replying. The keep mode is normally used when the user accesses her mail away from her primary computer (e.g., a laptop). The mail is read but kept in the system for later retrieval and organizing.



## **5. IMAP**

Another mail access protocol is Internet Mail Access Protocol, version 4 (IMAP4). IMAP4 is similar to POP3, but it has more features; IMAP4 is more powerful and more complex.

POP3 is deficient in several ways. It does not allow the user to organize her mail on the server; the user cannot have different folders on the server. In addition, POP3 does not allow the user to partially check the contents of the mail before downloading. IMAP4 provides the following extra functions:

- o A user can check the e-mail header prior to downloading.
- o A user can search the contents of the e-mail for a specific string of characters prior to downloading.
- o A user can partially download e-mail. This is especially useful if bandwidth is limited and the e-mail contains multimedia with high bandwidth requirements.
- o A user can create, delete, or rename mailboxes on the mail server.
- o A user can create a hierarchy of mailboxes in a folder for e-mail storage.

## **6. Web-Based Mail**

E-mail is such a common application that some websites today provide this service to anyone who accesses the site. Two common sites are *Hotmail* and *Yahoo*. The idea is very simple. Mail transfer from Alice's browser to her mail server is done through HTTP. The transfer of the message from the sending mail server to the receiving mail server is still through SMTP. Finally, the message from the receiving server (the Web server) to Bob's browser is done through HTTP. The last phase is very interesting. Instead of POP3 or IMAP4, HTTP is normally used. When Bob needs to retrieve his e-mails, he sends a message to the website (Hotmail, for example). The website sends a form to be filled in by Bob, which includes the log-in name and the password. If the log-in name and password match, the e-mail is transferred from the Web server to Bob's browser in HTML format.

## **7. FTP**

File Transfer Protocol (FTP) is the standard mechanism provided by *TCP/IP* for copying a file from one host to another. Although transferring files from one system to another seems simple and straightforward, some problems must be dealt with first. For example, two systems may use different file name conventions. Two systems may have different ways to represent text and data.

Two systems may have different directory structures. All these problems have been solved by FTP in a very simple and elegant approach.

FTP differs from other client/server applications in that it establishes two connections between the hosts. One connection is used for data transfer, the other for control information (commands and responses). Separation of commands and data transfer makes FTP more efficient. The control connection uses very simple rules of communication. We need to transfer only a line of command or a line of response at a time. The data connection, on the other hand, needs more complex rules due to the variety of data types transferred. However, the difference in complexity is at the FTP level, not TCP. For TCP, both connections are treated the same. FTP uses two well-known TCP ports: Port 21 is used for the control connection, and port 20 is used for the data connection.

Figure 26.21 shows the basic model of FTP. The client has three components: user interface, client control process, and the client data transfer process. The server has two components: the server control process and the server data transfer process. The control connection is made between the control processes. The data connection is made between the data transfer processes.

---

**Figure 26.21** *FTP*

---

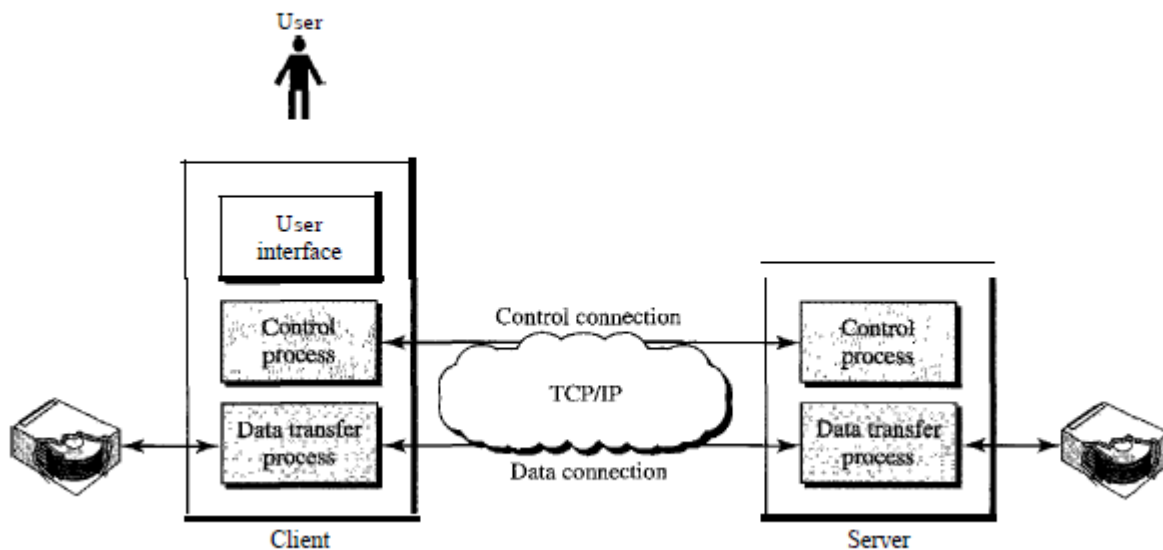

The control connection remains connected during the entire interactive FTP session. The data connection is opened and then closed for each file transferred. It opens each time commands that

involve transferring files are used, and it closes when the file is transferred. In other words, when a user starts an FTP session, the control connection opens. While the control connection is open, the data connection can be opened and closed multiple times if several files are transferred.

**Transmission Mode:** FTP can transfer a file across the data connection by using one of the following three transmission modes: stream mode, block mode, and compressed mode. The stream mode is the default mode. Data are delivered from FTP to TCP as a continuous stream of bytes. TCP is responsible for chopping data into segments of appropriate size. If the data are simply a stream of bytes (file structure), no end-of-file is needed. End-of-file in this case is the closing of the data connection by the sender. If the data are divided into records (record structure), each record will have a 1-byte end-of-record (EOR) character and the end of the file will have a 1-byte end-of-file (EOF) character. In block mode, data can be delivered from FTP to TCP in blocks. In this case, each block is preceded by a 3-byte header. The first byte is called the *block descriptor*; the next 2 bytes define the size of the block in bytes. In the compressed mode, if the file is big, the data can be compressed. The compression method normally used is run-length encoding. In this method, consecutive appearances of a data unit are replaced by one occurrence and the number of repetitions. In a text file, this is usually spaces (blanks). In a binary file, null characters are usually compressed.

## **8. HTTP**

The Hypertext Transfer Protocol (HTTP) is a protocol used mainly to access data on the World Wide Web. HTTP functions as a combination of FTP and SMTP. It is similar to FTP because it transfers files and uses the services of TCP. However, it is much simpler than FTP because it uses only one TCP connection. There is no separate control connection; only data are transferred between the client and the server. HTTP is like SMTP because the data transferred between the client and the server look like SMTP messages. In addition, the format of the messages is controlled by MIME-like headers. Unlike SMTP, the HTTP messages are not destined to be read by humans; they are read and interpreted by the HTTP server and HTTP client (browser). SMTP messages are stored and forwarded, but HTTP messages are delivered immediately. The commands from the client to the server are embedded in a request message. The contents of the requested file or other information are embedded in a response message. HTTP uses the services of TCP on well-known port 80.

## HTTP Transaction

Figure 27.12 illustrates the HTTP transaction between the client and server. Although HTTP uses the services of TCP, HTTP itself is a stateless protocol. The client initializes the transaction by sending a request message. The server replies by sending a response.

### Messages

The formats of the request and response messages are similar; both are shown in Figure 27.13. A request message consists of a request line, a header, and sometimes a body. A response message consists of a status line, a header, and sometimes a body.

---

Figure 27.12 *HTTP transaction*

---

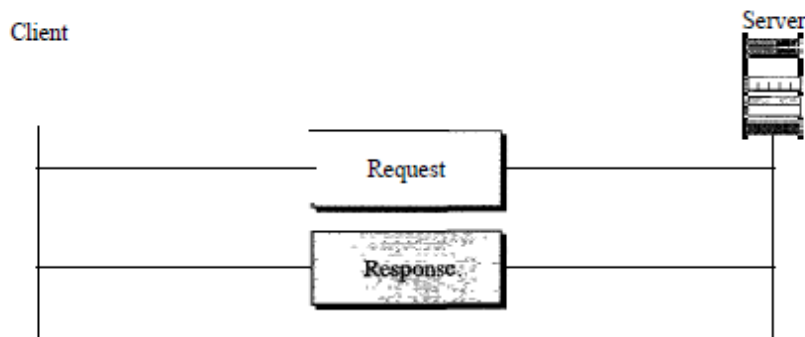

---

Figure 27.13 *Request and response messages*

---

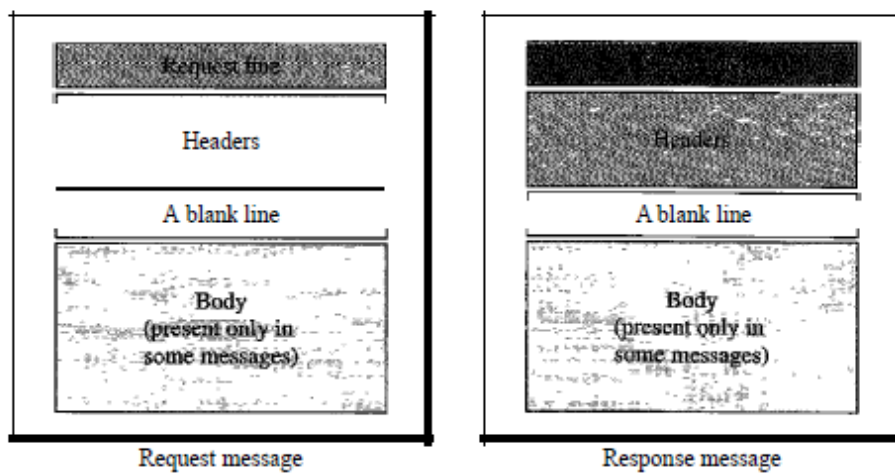

**Request and Status Lines:** The first line in a request message is called a request line; the first line in the response message is called the status line. There is one common field, as shown in Figure 27.14.

**Figure 27.14** *Request and status lines*

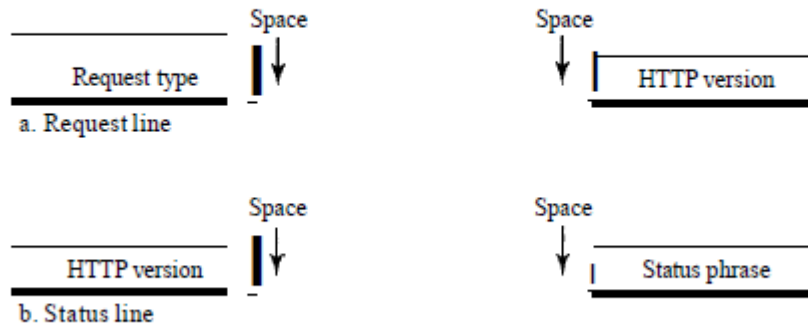

a. **Request type.** This field is used in the request message. In version 1.1 of HTTP, several request types are defined. The request type is categorized into *methods* as defined in Table 27.1.

**Table 27.1** *Methods*

<i>Method</i>	<i>Action</i>
GET	Requests a document from the server
HEAD	Requests information about a document but not the document itself
POST	Sends some information from the client to the server
PUT	Sends a document from the server to the client
TRACE	Echoes the incoming request
CONNECT	Reserved
OPTION	Inquires about available options

b. **URL.** URL means Uniform Resource Locator

c. **Version.** The current version of HTTP

d. **Status code.** This field is used in the response message. The status code field is similar to those in the FTP and the SMTP protocols. It consists of three digits. Whereas the codes in the 100 range are only informational, the codes in the 200 range indicate a successful request. The codes in the 300 range redirect the client to another URL, and the codes in the 400 range indicate

an error at the client site. Finally, the codes in the 500 range indicate an error at the server site. We list the most common codes in Table 27.2.

e. **Status phrase.** This field is used in the response message. It explains the status code in text form. Table 27.2 also gives the status phrase.

**Table 27.2** *Status codes*

<i>Code</i>	<i>Phrase</i>	<i>Description</i>
<b>Informational</b>		
100	Continue	The initial part of the request has been received, and the client may continue with its request.
101	Switching	The server is complying with a client request to switch protocols defined in the upgrade header.
<b>Success</b>		
200	OK	The request is successful.
201	Created	A new URL is created.
202	Accepted	The request is accepted, but it is not immediately acted upon.
204	No content	There is no content in the body.